



 Read this manual carefully before operating this vehicle.

OWNER'S MANUAL

**YZF-R1
YZF-R1M**

BX4-28199-E0

 **Read this manual carefully before operating this vehicle. This manual should stay with this vehicle if it is sold.**

Declaration of Conformity:

Hereby, YAMAHA MOTOR ELECTRONICS Co., Ltd declares that the radio equipment type, IMMOBILIZER, 2CR-00 is in compliance with Directive 2014/53/EU.

The full text of the EU declaration of conformity is available at the following internet address:

https://global.yamaha-motor.com/eu_doc/

Frequency band: 134.2 kHz

The maximum radio frequency power: 49.0 [dB μ V/m]

Manufacturer:

YAMAHA MOTOR ELECTRONICS Co., Ltd

1450-6 Mori, Mori-machi, Shuchi-Gun, Shizuoka, 437-0292 Japan

Importer:

YAMAHA MOTOR EUROPE N.V.

Koolhovenlaan 101, 1119 NC Schiphol-Rijk, 1117 ZN, Schiphol, the Netherlands

Declaration of Conformity:

Hereby, YAMAHA MOTOR CO., LTD declares that the radio equipment type, Communication Control Unit, 2KS-85800-00 is in compliance with Directive 2014/53/EU.

The full text of the EU declaration of conformity is available at the following internet address:

https://global.yamaha-motor.com/eu_doc/

Frequency band: 2.4 GHz

The maximum radio frequency power: 50.12 mW

Manufacturer:

YAMAHA MOTOR CO., LTD

2500 Shingai, Iwata, Shizuoka, 438-8501 Japan

Importer:

YAMAHA MOTOR EUROPE N.V.

Koolhovenlaan 101, 1119 NC Schiphol-Rijk, 1117 ZN, Schiphol, the Netherlands

Welcome to the Yamaha world of motorcycling!

As the owner of the YZF-R1/YZF-R1M, you are benefiting from Yamaha's vast experience and newest technology regarding the design and manufacture of high-quality products, which have earned Yamaha a reputation for dependability.

Please take the time to read this manual thoroughly, so as to enjoy all advantages of your YZF-R1/YZF-R1M. The Owner's Manual does not only instruct you in how to operate, inspect and maintain your motorcycle, but also in how to safeguard yourself and others from trouble and injury.

In addition, the many tips given in this manual will help keep your motorcycle in the best possible condition. If you have any further questions, do not hesitate to contact your Yamaha dealer.

The Yamaha team wishes you many safe and pleasant rides. So, remember to put safety first!

Yamaha continually seeks advancements in product design and quality. Therefore, while this manual contains the most current product information available at the time of printing, there may be minor discrepancies between your motorcycle and this manual. If there is any question concerning this manual, please consult a Yamaha dealer.





Please read this manual carefully and completely before operating this motorcycle.

Important manual information

EAU10134

Particularly important information is distinguished in this manual by the following notations:

	This is the safety alert symbol. It is used to alert you to potential personal injury hazards. Obey all safety messages that follow this symbol to avoid possible injury or death.
	A WARNING indicates a hazardous situation which, if not avoided, could result in death or serious injury.
NOTICE	A NOTICE indicates special precautions that must be taken to avoid damage to the vehicle or other property.
TIP	A TIP provides key information to make procedures easier or clearer.

*Product and specifications are subject to change without notice.

EAU10201

**YZF-R1/YZF-R1M
OWNER'S MANUAL
©2016 by Yamaha Motor Co., Ltd.
1st edition, November 2016
All rights reserved.
Any reprinting or unauthorized use
without the written permission of
Yamaha Motor Co., Ltd.
is expressly prohibited.
Printed in Japan.**

Table of contents

Safety information	1-1	CCU (for equipped models)	4-38	Removing and installing cowlings and panels.....	7-9
Description	2-1	Document storage.....	4-39	Checking the spark plugs	7-12
Left view	2-1	Rear view mirrors	4-40	Canister	7-13
Right view	2-2	Adjusting the front fork	4-40	Engine oil and oil filter cartridge...	7-13
Controls and instruments.....	2-3	Adjusting the shock absorber assembly.....	4-42	Coolant	7-16
Special features	3-1	EXUP system	4-46	Air filter element.....	7-18
YRC (Yamaha Ride Control)	3-1	Auxiliary DC connector.....	4-46	Checking the engine idling speed.....	7-19
Glossary	3-3	Sidestand	4-47	Checking the throttle grip free play.....	7-19
YRC functions visual guide.....	3-4	Ignition circuit cut-off system.....	4-47	Valve clearance	7-19
Instrument and control functions ...	4-1	For your safety – pre-operation checks	5-1	Tires.....	7-20
Immobilizer system.....	4-1	Operation and important riding points	6-1	Cast magnesium wheels.....	7-22
Main switch/steering lock.....	4-2	Starting the engine	6-1	Adjusting the clutch lever free play.....	7-23
Handlebar switches	4-3	Shifting	6-2	Checking the brake lever free play.....	7-24
Indicator lights and warning lights.....	4-6	Tips for reducing fuel consumption	6-3	Brake light switches	7-24
Display.....	4-9	Engine break-in	6-3	Checking the front and rear brake pads.....	7-25
MENU screen	4-15	Parking	6-4	Checking the brake fluid level.....	7-25
Clutch lever.....	4-30	Periodic maintenance and adjustment	7-1	Changing the brake fluid.....	7-26
Shift pedal.....	4-30	Owner's tool kit.....	7-2	Drive chain slack.....	7-27
Brake lever	4-31	Periodic maintenance chart for the emission control system	7-3	Cleaning and lubricating the drive chain	7-28
Brake pedal	4-31	General maintenance and lubrication chart	7-5	Checking and lubricating the cables	7-29
Brake system.....	4-32			Checking and lubricating the throttle grip and cable.....	7-29
Fuel tank cap	4-33				
Fuel.....	4-34				
Fuel tank breather hose and overflow hose	4-36				
Catalytic converter.....	4-36				
Seats	4-37				

Table of contents

- Checking and lubricating the
brake and shift pedals 7-29
- Checking and lubricating the
brake and clutch levers 7-30
- Checking and lubricating the
sidestand..... 7-31
- Lubricating the swingarm pivots ... 7-31
- Checking the front fork 7-31
- Checking the steering..... 7-32
- Checking the wheel bearings 7-32
- Battery 7-33
- Replacing the fuses..... 7-34
- Vehicle lights 7-36
- Supporting the motorcycle..... 7-37
- Troubleshooting..... 7-37
- Troubleshooting charts..... 7-39

- Motorcycle care and storage** 8-1
 - Matte color caution 8-1
 - Care..... 8-1
 - Storage..... 8-4

- Specifications** 9-1

- Consumer information** 10-1
 - Identification numbers 10-1
 - Diagnostic connector..... 10-2
 - Vehicle data recording..... 10-2

- Index** 11-1

Safety information

EAU1028C

1

Be a Responsible Owner

As the vehicle's owner, you are responsible for the safe and proper operation of your motorcycle.

Motorcycles are single-track vehicles. Their safe use and operation are dependent upon the use of proper riding techniques as well as the expertise of the operator. Every operator should know the following requirements before riding this motorcycle.

He or she should:

- Obtain thorough instructions from a competent source on all aspects of motorcycle operation.
- Observe the warnings and maintenance requirements in this Owner's Manual.
- Obtain qualified training in safe and proper riding techniques.
- Obtain professional technical service as indicated in this Owner's Manual and/or when made necessary by mechanical conditions.
- Never operate a motorcycle without proper training or instruction.

Take a training course. Beginners should receive training from a certified instructor. Contact an authorized motorcycle dealer to find out about the training courses nearest you.

Safe Riding

Perform the pre-operation checks each time you use the vehicle to make sure it is in safe operating condition. Failure to inspect or maintain the vehicle properly increases the possibility of an accident or equipment damage. See page 5-1 for a list of pre-operation checks.

- This motorcycle is designed to carry the operator and a passenger.
- The failure of motorists to detect and recognize motorcycles in traffic is the predominating cause of automobile/motorcycle accidents. Many accidents have been caused by an automobile driver who did not see the motorcycle. Making yourself conspicuous appears to be very effective in reducing the chance of this type of accident.

Therefore:

- Wear a brightly colored jacket.

- Use extra caution when you are approaching and passing through intersections, since intersections are the most likely places for motorcycle accidents to occur.
- Ride where other motorists can see you. Avoid riding in another motorist's blind spot.
- Never maintain a motorcycle without proper knowledge. Contact an authorized motorcycle dealer to inform you on basic motorcycle maintenance. Certain maintenance can only be carried out by certified staff.
- Many accidents involve inexperienced operators. In fact, many operators who have been involved in accidents do not even have a current motorcycle license.
- Make sure that you are qualified and that you only lend your motorcycle to other qualified operators.
- Know your skills and limits. Staying within your limits may help you to avoid an accident.
- We recommend that you prac-

tice riding your motorcycle where there is no traffic until you have become thoroughly familiar with the motorcycle and all of its controls.

- Many accidents have been caused by error of the motorcycle operator. A typical error made by the operator is veering wide on a turn due to excessive speed or undercornering (insufficient lean angle for the speed).
- Always obey the speed limit and never travel faster than warranted by road and traffic conditions.
- Always signal before turning or changing lanes. Make sure that other motorists can see you.
- The posture of the operator and passenger is important for proper control.
 - The operator should keep both hands on the handlebar and both feet on the operator footrests during operation to maintain control of the motorcycle.
 - The passenger should always hold onto the operator, the seat strap or grab bar, if equipped,

with both hands and keep both feet on the passenger footrests. Never carry a passenger unless he or she can firmly place both feet on the passenger footrests.

- Never ride under the influence of alcohol or other drugs.
- This motorcycle is designed for on-road use only. It is not suitable for off-road use.

Protective Apparel

The majority of fatalities from motorcycle accidents are the result of head injuries. The use of a safety helmet is the single most critical factor in the prevention or reduction of head injuries.

- Always wear an approved helmet.
- Wear a face shield or goggles. Wind in your unprotected eyes could contribute to an impairment of vision that could delay seeing a hazard.
- The use of a jacket, heavy boots, trousers, gloves, etc., is effective in preventing or reducing abrasions or lacerations.
- Never wear loose-fitting clothes, otherwise they could catch on the

control levers, footrests, or wheels and cause injury or an accident.

- Always wear protective clothing that covers your legs, ankles, and feet. The engine or exhaust system become very hot during or after operation and can cause burns.
- A passenger should also observe the above precautions.

Avoid Carbon Monoxide Poisoning

All engine exhaust contains carbon monoxide, a deadly gas. Breathing carbon monoxide can cause headaches, dizziness, drowsiness, nausea, confusion, and eventually death.

Carbon Monoxide is a colorless, odorless, tasteless gas which may be present even if you do not see or smell any engine exhaust. Deadly levels of carbon monoxide can collect rapidly and you can quickly be overcome and unable to save yourself. Also, deadly levels of carbon monoxide can linger for hours or days in enclosed or poorly ventilated areas. If you experience any symptoms of carbon monoxide poisoning, leave the area immediately, get fresh air, and SEEK MEDICAL TREAT-

Safety information

1

MENT.

- Do not run engine indoors. Even if you try to ventilate engine exhaust with fans or open windows and doors, carbon monoxide can rapidly reach dangerous levels.
- Do not run engine in poorly ventilated or partially enclosed areas such as barns, garages, or carports.
- Do not run engine outdoors where engine exhaust can be drawn into a building through openings such as windows and doors.

Loading

Adding accessories or cargo to your motorcycle can adversely affect stability and handling if the weight distribution of the motorcycle is changed. To avoid the possibility of an accident, use extreme caution when adding cargo or accessories to your motorcycle. Use extra care when riding a motorcycle that has added cargo or accessories. Here, along with the information about accessories below, are some general guidelines to follow if loading cargo to your motorcycle:

The total weight of the operator, passenger, accessories and cargo must not exceed the maximum load limit.

Operation of an overloaded vehicle could cause an accident.

Maximum load: 187 kg (412 lb)

When loading within this weight limit, keep the following in mind:

- Cargo and accessory weight should be kept as low and close to the motorcycle as possible. Securely pack your heaviest items as close to the center of the vehicle as possible and make sure to distribute the weight as evenly as possible on both sides of the motorcycle to minimize imbalance or instability.
- Shifting weights can create a sudden imbalance. Make sure that accessories and cargo are securely attached to the motorcycle before riding. Check accessory mounts and cargo restraints frequently.
 - Properly adjust the suspension for your load (suspension-ad-

justable models only), and check the condition and pressure of your tires.

- Never attach any large or heavy items to the handlebar, front fork, or front fender. These items, including such cargo as sleeping bags, duffel bags, or tents, can create unstable handling or a slow steering response.
- **This vehicle is not designed to pull a trailer or to be attached to a sidecar.**

Genuine Yamaha Accessories

Choosing accessories for your vehicle is an important decision. Genuine Yamaha accessories, which are available only from a Yamaha dealer, have been designed, tested, and approved by Yamaha for use on your vehicle.

Many companies with no connection to Yamaha manufacture parts and accessories or offer other modifications for Yamaha vehicles. Yamaha is not in a position to test the products that these aftermarket companies produce. Therefore, Yamaha can neither en-

dorse nor recommend the use of accessories not sold by Yamaha or modifications not specifically recommended by Yamaha, even if sold and installed by a Yamaha dealer.

Aftermarket Parts, Accessories, and Modifications

While you may find aftermarket products similar in design and quality to genuine Yamaha accessories, recognize that some aftermarket accessories or modifications are not suitable because of potential safety hazards to you or others. Installing aftermarket products or having other modifications performed to your vehicle that change any of the vehicle's design or operation characteristics can put you and others at greater risk of serious injury or death. You are responsible for injuries related to changes in the vehicle.

Keep the following guidelines in mind, as well as those provided under "Loading" when mounting accessories.

- Never install accessories or carry cargo that would impair the performance of your motorcycle. Carefully inspect the accessory before

using it to make sure that it does not in any way reduce ground clearance or cornering clearance, limit suspension travel, steering travel or control operation, or obscure lights or reflectors.

- Accessories fitted to the handlebar or the front fork area can create instability due to improper weight distribution or aerodynamic changes. If accessories are added to the handlebar or front fork area, they must be as lightweight as possible and should be kept to a minimum.
- Bulky or large accessories may seriously affect the stability of the motorcycle due to aerodynamic effects. Wind may attempt to lift the motorcycle, or the motorcycle may become unstable in cross winds. These accessories may also cause instability when passing or being passed by large vehicles.
- Certain accessories can displace the operator from his or her normal riding position. This improper position limits the free-

dom of movement of the operator and may limit control ability, therefore, such accessories are not recommended.

- Use caution when adding electrical accessories. If electrical accessories exceed the capacity of the motorcycle's electrical system, an electric failure could result, which could cause a dangerous loss of lights or engine power.

Aftermarket Tires and Rims

The tires and rims that came with your motorcycle were designed to match the performance capabilities and to provide the best combination of handling, braking, and comfort. Other tires, rims, sizes, and combinations may not be appropriate. See page 7-20 for tire specifications and for information on servicing and replacing your tires.

Transporting the Motorcycle

Be sure to observe following instructions before transporting the motorcycle in another vehicle.

- Remove all loose items from the motorcycle.

Safety information

1

- Check that the fuel cock (if equipped) is in the off position and that there are no fuel leaks.
- Shift the transmission into gear (for models with a manual transmission).
- Secure the motorcycle with tie-downs or suitable straps that are attached to solid parts of the motorcycle, such as the frame or upper front fork triple clamp (and not, for example, to rubber-mounted handlebars or turn signals, or parts that could break). Choose the location for the straps carefully so the straps will not rub against painted surfaces during transport.
- The suspension should be compressed somewhat by the tie-downs, if possible, so that the motorcycle will not bounce excessively during transport.

Left view

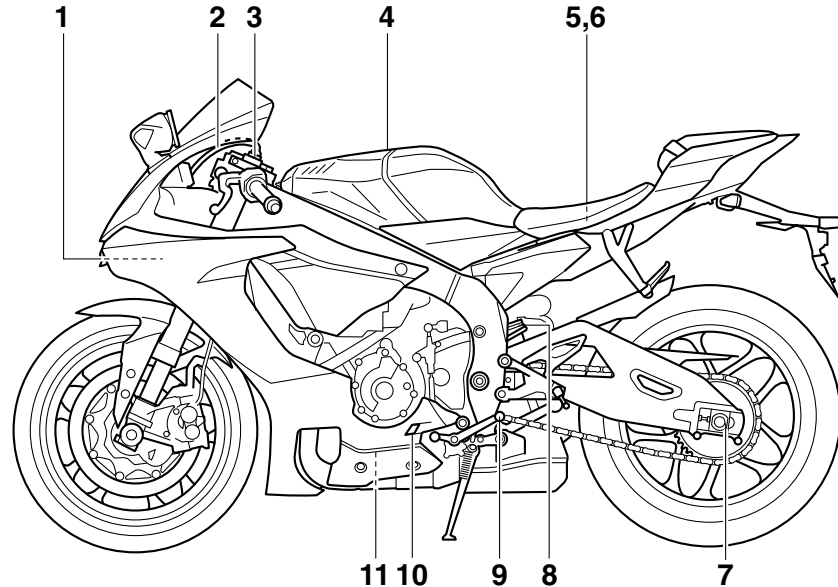

1. Fuse box (page 7-34)
2. ERS coupler (YZF-R1M) (page 4-40)
3. Spring preload adjusting bolt (YZF-R1M) (page 4-40)
4. Fuel tank cap (page 4-33)
5. Battery (page 7-33)
6. Main fuse (page 7-34)
7. Drive chain puller (page 7-27)
8. Spring preload adjusting ring (page 4-42)

9. Shift pedal (page 4-30)
10. Engine oil level check window (page 7-13)
11. Engine oil filter cartridge (page 7-13)

Description

EAU10421

Right view

2

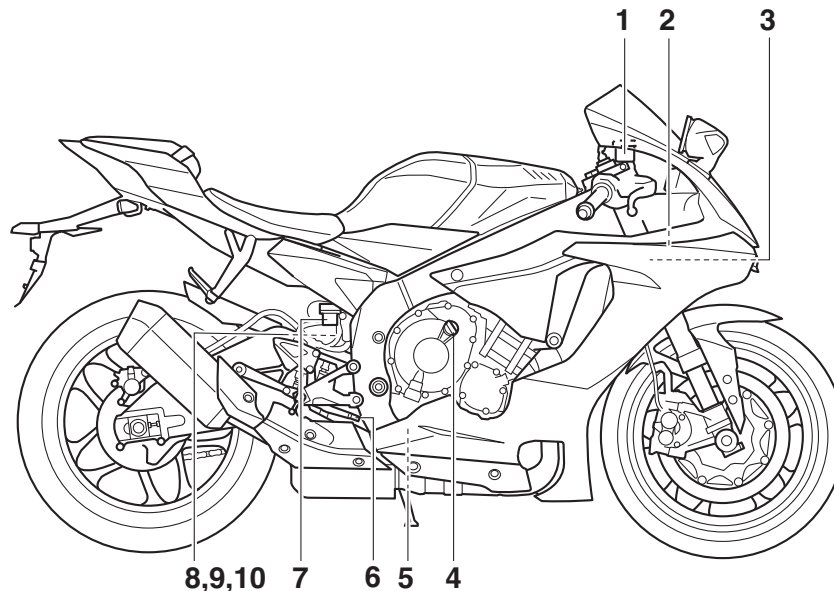

1. Front brake fluid reservoir (page 7-25)

2. Document storage space (page 4-39)

3. Radiator cap (page 7-16)

4. Engine oil filler cap (page 7-13)

5. Coolant drain bolt (page 7-17)

6. Brake pedal (page 4-31)

7. Rear brake fluid reservoir (page 7-25)

8. Fast compression damping adjuster (YZF-R1) (page 4-42)

9. Slow compression damping adjuster (YZF-R1) (page 4-42)

10. Rebound damping adjuster (YZF-R1) (page 4-42)

Controls and instruments

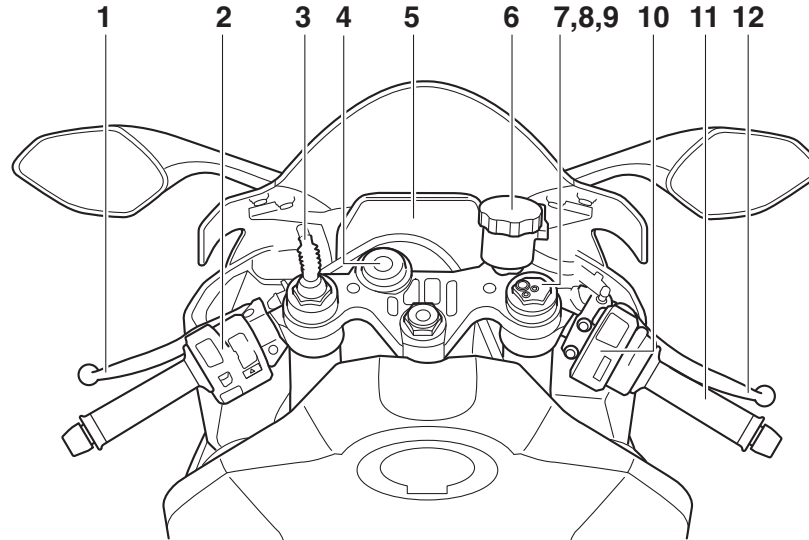

1. Clutch lever (page 4-30)
2. Left handlebar switches (page 4-3)
3. ERS coupler (YZF-R1M) (page 4-40)
4. Main switch/steering lock (page 4-2)
5. Instrument panel (page 4-6, 4-9)
6. Front brake fluid reservoir (page 7-25)
7. Spring preload adjusting nut (YZF-R1) (page 4-40)
8. Rebound damping force adjusting bolt (YZF-R1)(page 4-40)
9. Compression damping force adjusting bolt (YZF-R1) (page 4-40)
10. Right handlebar switches (page 4-3)
11. Throttle grip (page 7-19)
12. Brake lever (page 4-31)

Special features

EAU66292

YRC (Yamaha Ride Control)

Yamaha Ride Control is a system that incorporates numerous sensors and controls to support an improved riding experience. The vehicle senses and can react to forces along the longitudinal (front-to-back), lateral (left-to-right), and vertical (up-and-down) axes. Lean angle and G-force accelerations are also detected. This information is processed multiple times a second and the related physical systems are automatically adjusted as necessary. The functions listed below represent individual YRC items which can be turned on/off or adjusted to suit various riders and riding conditions. For setting details see “MENU screen” on page 4-15.

EWA18220

⚠ WARNING

The Yamaha Ride Control (YRC) system is not a substitute for the use of proper riding techniques or the expertise of the operator. This system cannot prevent loss of control caused by rider errors such as traveling faster than warranted by road and traffic conditions, including loss

of traction due to excessive speed when entering turns, when accelerating hard at a sharp lean angle, or while braking, and it cannot prevent front wheel slipping or lift (“wheelies”). As with any motorcycle, always ride within in your limits, be aware of surrounding conditions, and ride appropriately for those conditions. Become thoroughly familiar with the way the motorcycle handles with various YRC settings before attempting more advanced maneuvers.

PWR

The power delivery mode system consists of four different control maps which regulate throttle valve opening in relation to the degree of throttle grip operation, thus providing you with a selection of modes to fit your preferences and the riding environment.

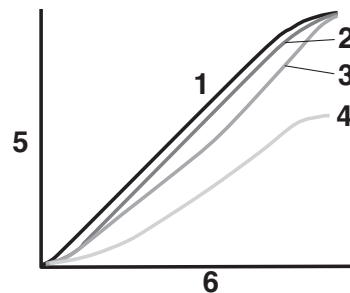

1. PWR 1
2. PWR 2
3. PWR 3
4. PWR 4
5. Throttle valve opening
6. Throttle grip operation

TCS

The traction control system helps maintain traction when accelerating. If sensors detect that the rear wheel is starting to slip (uncontrolled spinning), the traction control system assists by regulating engine power as needed until traction is restored. The traction control system indicator/warning light flashes to let the rider know that traction control has engaged.

This traction control system automati-

cally adjusts according to the vehicle's lean angle. To maximize acceleration, when the vehicle is upright a less amount of traction control is applied. When cornering, a greater amount of traction control is applied.



TIP

- The traction control system may engage when the vehicle travels over a bump.
- You may notice slight changes in engine and exhaust sounds when the traction control or other YRC systems engage.
- When TCS is turned off, SCS, LCS, and LIF are also turned off automatically.

⚠ WARNING

The traction control system is not a substitute for riding appropriately for the conditions. Traction control cannot prevent loss of traction due to excessive speed when entering turns, when accelerating hard at a sharp lean angle, or while braking, and cannot prevent front wheel slipping. As with any motorcycle, approach surfaces that may be slippery with caution and avoid especially slippery surfaces.

When the key is turned to “ON”, the traction control system automatically turns on. The traction control system can be turned on or off manually only when the key is in the “ON” position and the motorcycle is stopped.

TIP

Turn the traction control system off to help free the rear wheel if the motorcycle gets stuck in mud, sand, or other soft surfaces.

NOTICE

Use only the specified tires. (See page 7-20.) Using different sized tires will prevent the traction control system from controlling tire rotation accurately.

SCS

The slide control system regulates engine power output when a sideward slide is detected in the rear wheel. It adjusts power output based on data from the IMU. This system supports the TCS to contribute to a smoother ride.

LCS

The launch control system helps the rider achieve smooth and swift launches from the starting grid. It keeps engine speed from rising above 10,000 r/min even when the throttle grip is fully turned. The LCS regulates engine power output in conjunction with the TCS and LIF systems for optimal traction and reduced wheel lift.

Special features

ECA22950

NOTICE

Even when using LCS, the clutch lever must be released gradually to avoid clutch damage.

TIP

LCS is intended for track use only.

QSS

The quick shift system allows for full-throttle, clutch lever-less, electronically-assisted upshifts. When the switch positioned on the shift lever rod detects motion in the shift lever, engine power output is adjusted and drive torque is momentarily cancelled out to allow for the gear change to occur.

TIP

- QSS operates when traveling at least 20 km/h with an engine speed of 2000 r/min or higher and only when accelerating.
 - QSS does not operate when the clutch lever is pulled.
-

LIF

The lift control system reduces the rate at which the front wheel will continue to rise during extreme acceleration, such as during starts or out-of-corner exits. When front-wheel lift is detected, engine power is regulated to slow front-wheel lift while still providing good acceleration.

ERS (YZF-R1M)

The Electronic Racing Suspension by Öhlins features electrically-controlled suspension damping. The system is controlled by the SCU which makes independent adjustments of both the front and rear suspension's compression stroke and rebound stroke damping forces. There are two modes, automatic and manual. Automatic mode is an active suspension control system which actively adjusts suspension damping forces based on running conditions. Manual mode is a finely-tunable traditional suspension set-up.

EAU66311

Glossary

ABS - Anti-lock Brake System
ABS ECU - Anti-lock Brake System Electronic Control Unit
CCU - Communication Control Unit
ECU - Engine Control Unit
ERS - Electronic Racing Suspension
GPS - Global Positioning System
IMU - Inertial Measurement Unit
LCS - Launch Control System
LIF - Lift Control System
PWR - Power delivery mode
QSS - Quick Shift System
SC - Stability Control
SCS - Slide Control System
SCU - Suspension Control Unit
TCS - Traction Control System
UBS - Unified Brake System
YRC - Yamaha Ride Control

YRC functions visual guide

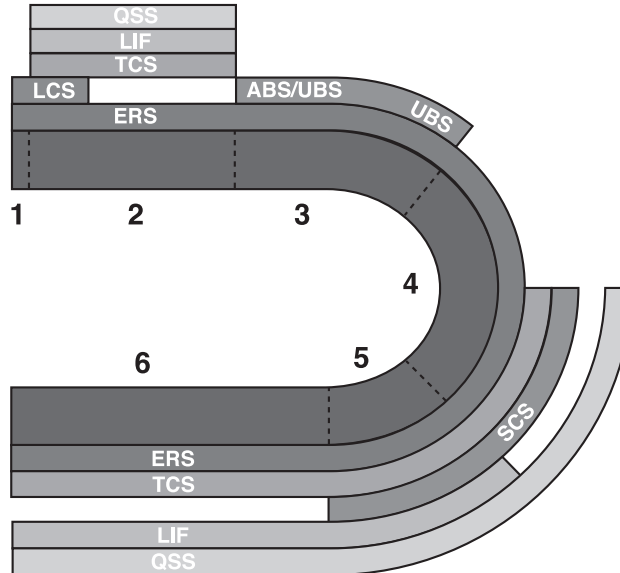

1. Start
2. Acceleration
3. Braking
4. Apex
5. Exit

6. Straightaway

Instrument and control functions

Immobilizer system

EAU10978

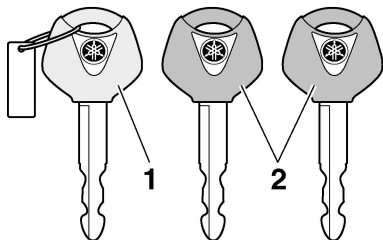

1. Code re-registering key (red bow)
2. Standard keys (black bow)

This vehicle is equipped with an immobilizer system to help prevent theft by re-registering codes in the standard keys. This system consists of the following:

- a code re-registering key (with a red bow)
- two standard keys (with a black bow) that can be re-registered with new codes
- a transponder (which is installed in the code re-registering key)
- an immobilizer unit
- an ECU
- an immobilizer system indicator

light (See page 4-7.)

The key with the red bow is used to register codes in each standard key. Since re-registering is a difficult process, take the vehicle along with all three keys to a Yamaha dealer to have them re-registered. Do not use the key with the red bow for driving. It should only be used for re-registering the standard keys. Always use a standard key for driving.

ECA11822

NOTICE

- **DO NOT LOSE THE CODE RE-REGISTERING KEY! CONTACT YOUR DEALER IMMEDIATELY IF IT IS LOST!** If the code re-registering key is lost, registering new codes in the standard keys is impossible. The standard keys can still be used to start the vehicle, however if code re-registering is required (i.e., if a new standard key is made or all keys are lost) the entire immobilizer system must be replaced. Therefore, it is highly recommended to use either standard key and keep the code re-registering key in a safe

place.

- Do not submerge any key in water.
- Do not expose any key to excessively high temperatures.
- Do not place any key close to magnets (this includes, but not limited to, products such as speakers, etc.).
- Do not place items that transmit electrical signals close to any key.
- Do not place heavy items on any key.
- Do not grind any key or alter its shape.
- Do not disassemble the plastic part of any key.
- Do not put two keys of any immobilizer system on the same key ring.
- Keep the standard keys as well as keys of other immobilizer systems away from this vehicle's code re-registering key.
- Keep other immobilizer system keys away from the main switch as they may cause signal inter-

ference.

Main switch/steering lock

EAU10474

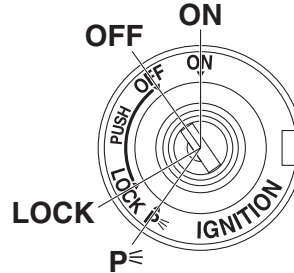

The main switch/steering lock controls the ignition and lighting systems, and is used to lock the steering. The various positions are described below.

TIP

Be sure to use the standard key (black bow) for regular use of the vehicle. To minimize the risk of losing the code re-registering key (red bow), keep it in a safe place and only use it for code re-registering.

ON

EAU10552

All electrical circuits are supplied with power. The meter lighting, taillight, li-

cense plate light and auxiliary lights come on, and the engine can be started. The key cannot be removed.

TIP

The headlights come on automatically when the engine is started and stay on until the key is turned to “OFF”, even if the engine stalls.

4

EAU10662

OFF

All electrical systems are off. The key can be removed.

EWA10062

WARNING

Never turn the key to “OFF” or “LOCK” while the vehicle is moving. Otherwise the electrical systems will be switched off, which may result in loss of control or an accident.

EAU1068B

LOCK

The steering is locked and all electrical systems are off. The key can be removed.

Instrument and control functions

To lock the steering

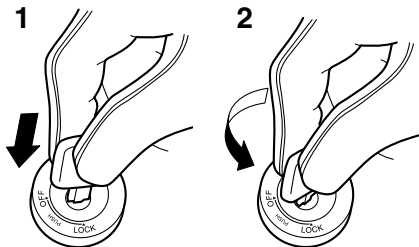

1. Push.
2. Turn.

1. Turn the handlebars all the way to the left.
2. With the key in the “OFF” position, push the key in and turn it to “LOCK”.
3. Remove the key.

TIP
If the steering will not lock, try turning the handlebars back to the right slightly.

To unlock the steering

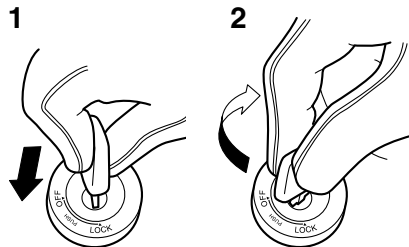

1. Push.
2. Turn.

From the “LOCK” position, push the key in and turn it to “OFF”.

EAU65680

p< (Parking)

The hazard lights can be turned on, but all other electrical systems are off. The key can be removed.

The steering must be locked before the key can be turned to “p<”.

ECA22330

NOTICE

Using the hazard lights for an extended length of time may cause the battery to discharge.

EAU66054

Handlebar switches

Left

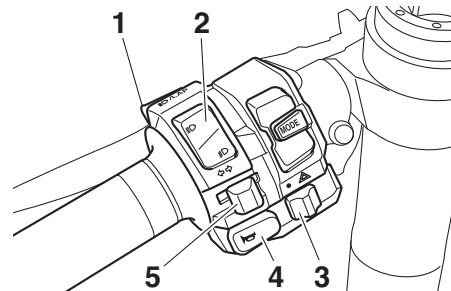

1. Pass/LAP switch “≡/LAP”
2. Dimmer switch “≡/≡”
3. Hazard switch “△”
4. Horn switch “”
5. Turn signal switch “←/→”

Instrument and control functions

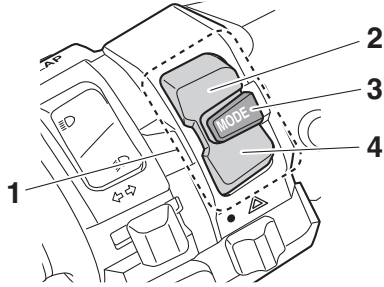

1. Mode switch “MODE”
2. Up button
3. Center button
4. Down button

Right

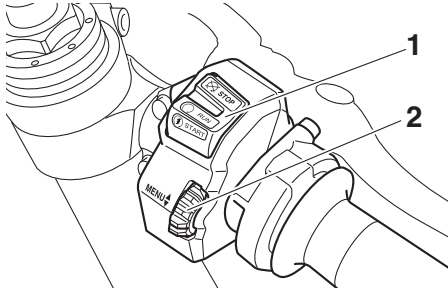

1. Stop/Run/Start switch “ \boxtimes / \circ / \ominus ”
2. Wheel switch “MENU \blacklozenge ”

Pass/LAP switch “ \boxtimes / \circ /LAP”

EAU66091

Press this switch to flash the headlights and to mark the start of each lap when using the lap timer.

Dimmer switch “ \boxtimes / \circ / \boxtimes ”

EAU66021

Set this switch to “ \boxtimes ” for the high beam and to “ \circ ” for the low beam. (See page 7-36.)

Turn signal switch “ \leftarrow / \rightarrow ”

EAU66040

To signal a right-hand turn, push this switch to “ \rightarrow ”. To signal a left-hand turn, push this switch to “ \leftarrow ”. When released, the switch returns to the center position. To cancel the turn signal lights, push the switch in after it has returned to the center position.

Horn switch “ \blacktriangle ”

EAU66030

Press this switch to sound the horn.

Stop/Run/Start switch “ \boxtimes / \circ / \ominus ”

EAU66060

To crank the engine with the starter, set this switch to “ \circ ”, and then push the

switch down towards “ \ominus ”. See page 6-1 for starting instructions prior to starting the engine.

Set this switch to “ \boxtimes ” to stop the engine in case of an emergency, such as when the vehicle overturns or when the throttle cable is stuck.

Hazard switch “ \triangle ”

EAU66010

With the key in the “ON” or “P \in ” position, use this switch to turn on the hazard lights (simultaneous flashing of all turn signal lights).

The hazard lights are used in case of an emergency or to warn other drivers when your vehicle is stopped where it might be a traffic hazard.

ECA10062

NOTICE

Do not use the hazard lights for an extended length of time with the engine not running, otherwise the battery may discharge.

Mode switch “MODE”

EAU66111

Use the mode switch to change YRC modes or edit the PWR, TCS, and SCS

Instrument and control functions

settings from the main screen. This switch has three buttons.

Up button - push this button to change the selected YRC setting upward.

Center button - push this button to scroll left to right among the MODE, PWR, TCS, and SCS items.

Down button - push this button to change the selected YRC setting downward.

TIP

- The center button is also used to activate the launch control system. When the LCS icon is grey, push and hold the center button. The LCS icon will flash and turn white when the system has been activated.
- The traction control system can only be turned off from the main screen. Select TCS with the center button, then push and hold the up button until TCS OFF is displayed. To turn the traction control system back on, use the down button.
- When TCS has been turned off, the SCS, LCS, and LIF systems are also turned off for all YRC

modes.

- See “YRC Setting” on page 4-16 for more information on how to customize YRC modes and adjust YRC item setting levels.

EAU66100

Wheel switch “MENU”

When the main screen is set to STREET MODE, use the wheel switch to scroll and reset the information display items.

When the main screen is set to TRACK MODE, use the wheel switch to scroll and reset the information display items and to activate the lap timer.

When the display has been changed to the MENU screen, use the wheel switch to navigate the setting modules and make setting changes.

Operate the wheel switch as follows.

Rotate up - rotate the wheel upward to scroll up/left or increase a setting value.

Rotate down - rotate the wheel downward to scroll down/right or decrease a setting value.

Short push - briefly press the switch inward to make and confirm selections.

Long push - press the switch inward

for one second to reset an information display item or to access and exit the MENU screen.







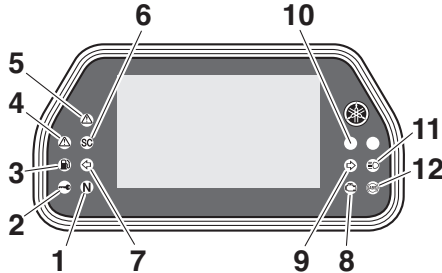

TIP

- See page 4-9 for more information on the main screen and its functions.
- See page 4-15 for more information on the MENU screen and how to make setting changes.

Indicator lights and warning lights

EAU4939C



1. Neutral indicator light “N”
2. Immobilizer system indicator light “”
3. Fuel level warning light “”
4. Oil pressure and coolant temperature warning light “”
5. Steering damper and suspension warning light “”
6. Stability control indicator light “SC”
7. Left turn signal indicator light “”
8. Engine trouble warning light “”
9. Right turn signal indicator light “”
10. Shift timing indicator light
11. High beam indicator light “”
12. ABS warning light “”

Turn signal indicator light “ ”

EAU11022

This indicator light flashes when a turn signal light is flashing.

Neutral indicator light “N”

EAU11061

This indicator light comes on when the transmission is in the neutral position.

High beam indicator light “”

EAU11081

This indicator light comes on when the high beam of the headlight is switched on.

Fuel level warning light “”

EAU66890

This warning light comes on when the fuel level drops below approximately 3.0 L (0.79 US gal, 0.66 Imp.gal). When this occurs, refuel as soon as possible. The electrical circuit of the warning light can be checked by turning the key to “ON”. The warning light should come on for a few seconds and then go off.

TIP

If the warning light does not come on at all, remains on after refueling, or if the warning light flashes repeatedly, have

a Yamaha dealer check the vehicle.

Engine trouble warning light “”

EAU79310

This warning light comes on if a problem is detected in the engine. If this occurs, have a Yamaha dealer check the on-board diagnostic system.

The electrical circuit of the warning light can be checked by turning the vehicle power on. The warning light should come on for a few seconds, and then go off.

If the warning light does not come on at all, or if the warning light remains on, have a Yamaha dealer check the vehicle.

ABS warning light “”

EAU66502

In normal operation, the ABS warning light comes on when the key is turned to “ON”, and goes off after traveling at a speed of 10 km/h (6 mi/h) or higher.

TIP

If the warning light does not work as described above, or if the warning light comes on while riding, the ABS and

Instrument and control functions

UBS may not work correctly. Have a Yamaha dealer check the vehicle as soon as possible.

EWA16041

WARNING

If the ABS warning light does not go off after traveling at a speed of 10 km/h (6 mi/h) or higher, or if the warning light comes on or flashes while riding, the brake system reverts to conventional braking. If either of the above occurs, or if the warning light does not come on at all, use extra caution to avoid possible wheel lock during emergency braking. Have a Yamaha dealer check the brake system and electrical circuits as soon as possible.

EAU67431

Shift timing indicator light

This indicator light can be set to come on and go off at the desired engine speeds and is used to inform the rider when it is time to shift to the next higher gear. (See page 4-24.)

The electrical circuit of the indicator light can be checked by turning the key

to ON. The indicator light should come on for a few seconds, and then go off. If the indicator light does not come on initially when the key is turned to ON, or if the indicator light remains on, have a Yamaha dealer check the electrical circuit.

EAU73120

Immobilizer system indicator light “ When the key is turned to “OFF” and 30 seconds have passed, the indicator light will flash steadily to indicate the immobilizer system is enabled. After 24 hours have passed, the indicator light will stop flashing, however the immobilizer system is still enabled.

The electrical circuit of the indicator light can be checked by turning the key to “ON”. The indicator light should come on for a few seconds, and then go off.

If the indicator light does not come on initially when the key is turned to “ON”, if the indicator light remains on, or if the indicator light flashes in a pattern (if a problem is detected in the immobilizer system, the immobilizer system indica-

tor light will flash in a pattern), have a Yamaha dealer check the vehicle.

TIP

If the immobilizer system indicator light flashes in the pattern, slowly 5 times then quickly 2 times, this could be caused by transponder interference. If this occurs, try the following.

1. Make sure there are no other immobilizer keys close to the main switch. Other immobilizer system keys may cause signal interference and prevent the engine from starting.
2. Use the code re-registering key to start the engine.
3. If the engine starts, turn it off, and try starting the engine with the standard keys.
4. If one or both of the standard keys do not start the engine, take the vehicle and all 3 keys to a Yamaha dealer to have the standard keys re-registered.

EAU65980

Stability control indicator light “SC”

This indicator light comes on when the

TCS, SCS, or LIF systems have engaged. It will also come on if the TCS is set to “OFF” or if the TCS system becomes disabled while riding.

The electrical circuit of the light can be checked by turning the key to “ON”. The light should come on for a few seconds and then go off. If the light does not come on initially when the key is turned to “ON”, or if the light remains on, have a Yamaha dealer check the vehicle.

EAU78410

Oil pressure and coolant temperature warning light “”

This warning light comes on if the engine oil pressure is low or if the coolant temperature is high. If this occurs, stop the engine immediately.

The electrical circuit of the warning light can be checked by turning the key to “ON”. The warning light should come on again after going off briefly, and then remain on until the engine is started. If the warning light does not come on initially when the key is turned to “ON”, have a Yamaha dealer check the electrical circuit.

ECA22441

NOTICE

If the oil pressure and coolant warning light does not go off after starting the engine or if it comes on while the engine is running, stop the vehicle and engine immediately.

- **If the engine is overheating, the coolant temperature warning icon will come on. Let the engine cool. Check the coolant level (see page 7-40).**
- **If the engine oil pressure is low, the oil pressure warning icon will come on. Check the oil level (see page 7-13).**
- **If the warning light remains on after letting the engine cool and confirming the proper oil level, have a Yamaha dealer check the vehicle. Do not continue to operate the vehicle!**

EAU78423

Steering damper and suspension warning light “”

This warning light comes on if a problem is detected in the electronic suspension or steering damper.

TIP

When the vehicle is turned on, this light should come on for a few seconds and then go off. If the light does not come on, or if the light remains on, have a Yamaha dealer check the vehicle.

Instrument and control functions

EAU79281

Display

The display has two different main screen display modes, STREET MODE and TRACK MODE. Most of the functions are viewable in either mode, but the layout differs slightly. The following items can be found on the display.

- Speedometer
- Tachometer
- Information display
- Transmission gear display
- Front brake pressure indicator
- Acceleration indicator
- YRC setting display MODE/PWR/TCS/SCS
- YRC setting display LCS/QS/LIF
- ERS indicator (ERS-equipped models)
- GPS indicator (CCU-equipped models)
- Clock
- Revolution peak hold indicator
- Lap timer
- Various warning icons
- Error mode warning “Err”

TIP

This model uses a thin-film-transistor liquid-crystal display (TFT LCD) for good contrast and readability in various lighting conditions. However, due to the nature of this technology, it is normal for a small number of pixels to be inactive.

STREET MODE

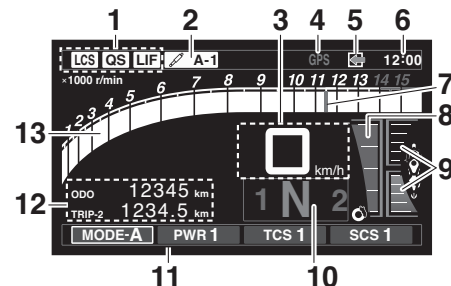



1. YRC items LCS/QS/LIF
2. ERS indicator (YZF-R1M)
3. Speedometer
4. GPS indicator (CCU-equipped models)
5. Logging indicator (CCU-equipped models)
6. Clock
7. Revolution peak hold indicator
8. Front brake pressure indicator
9. Acceleration indicator
10. Transmission gear display
11. YRC items MODE/PWR/TCS/SCS
12. Information display
13. Tachometer

Instrument and control functions

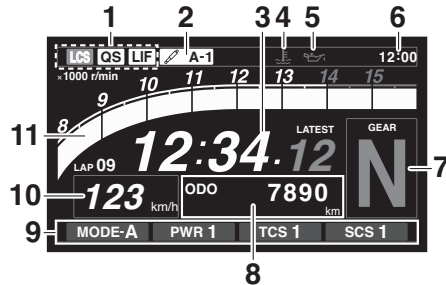
TRACK MODE



1. YRC items LCS/QS/LIF
2. ERS indicator (YZF-R1M)
3. Lap timer
4. Coolant temperature warning “ ”
5. Oil pressure warning “ ”
6. Clock
7. Transmission gear display
8. Information display
9. YRC items MODE/PWR/TCS/SCS
10. Speedometer
11. Tachometer

EWA18210

WARNING

Stop the vehicle before making any setting changes. Changing settings while riding can distract the operator and increase the risk of an acci-

dent.

Speedometer

The speedometer shows the vehicle's traveling speed.

TIP

The display can be switched between kilometers and miles. See “Unit” on page 4-22.

Tachometer

The tachometer shows the engine speed, as measured by the rotational velocity of the crankshaft, in revolutions per minute (r/min).

TIP

- In TRACK MODE, the tachometer starts at 8000 r/min.
- In STREET MODE, the tachometer can be color-adjusted and has a revolution peak hold indicator which can be turned on or off.

ECA10032

NOTICE

Do not operate the engine in the tachometer red zone.

Red zone: 14000 r/min and above

Information display

This section of the main screen is used to show additional riding related information such as air and coolant temperature readings, tripmeters, and fuel consumption statistics. The information display items can be set into four groups via the MENU screen.

The information display items are:

A.TEMP: air temperature

C.TEMP: coolant temperature

TRIP-1: tripmeter 1

TRIP-2: tripmeter 2

F-TRIP: fuel tripmeter

ODO: odometer

FUEL CON: the amount of fuel consumed

FUEL AVG: average fuel consumption

CRNT FUEL: current fuel consumption

TIP

- ODO will lock at 999999 and cannot be reset.
- TRIP-1 and TRIP-2 will reset to 0 and begin counting again after 9999.9 has been reached.
- When the fuel tank reserve level

Instrument and control functions

4

has been reached, F-TRIP appears automatically and begins recording distance traveled from that point.

- After refueling and traveling some distance, F-TRIP will automatically disappear.
 - See “Unit” on page 4-22 to change the fuel consumption units.
 - In TRACK MODE, information display items FASTEST (fastest lap time) and AVERAGE (average lap time) are also available.
-

TRIP-1, TRIP-2, F-TRIP, FUEL CON, and FUEL AVE items can be individually reset.

To reset information display items

1. Use the wheel switch to scroll through the display items until the item you want to reset appears.
2. Short push the wheel switch and the item will flash for five seconds. (For STREET MODE, if both items are resettable items, the top item will flash first. Scroll down to select the bottom item.)

3. While the item is flashing, press and hold the wheel switch for one second.

Transmission gear display

This shows which gear the transmission is in. This model has 6 gears and a neutral position. The neutral position is indicated by the neutral indicator light “N” and by the transmission gear display “N”.

Front brake pressure indicator

This shows how much braking power is being applied to the front brakes.

Acceleration indicator

This shows the vehicle’s forward acceleration and deceleration forces.

Revolution peak hold indicator

This small bar momentarily appears within the tachometer to mark the most recent peak engine speed.

YRC items MODE/PWR/TCS/SCS

The current MODE (YRC mode) and its related PWR, TCS and SCS settings are shown here.

The individual settings for YRC items PWR, TCS, SCS, LCS, QSS and LIF can be organized into four groups and set independently for each group. These groups of settings are the YRC modes MODE-A, MODE-B, MODE-C, and MODE-D. Use the mode switch to change YRC modes or make YRC item setting changes from the main screen.

TIP

The YRC modes come preset from the factory for different riding conditions. When using the factory presets, the suggested YRC modes are as follows.

- MODE-A is suitable for track riding.
 - MODE-B is a softer track-riding setting.
 - MODE-C is suitable for street riding.
 - MODE-D is suitable for touring or rainy weather.
-

To change YRC modes or make setting changes

1. Push the mode switch center button to scroll left to right and highlight the item you want to adjust.

Instrument and control functions

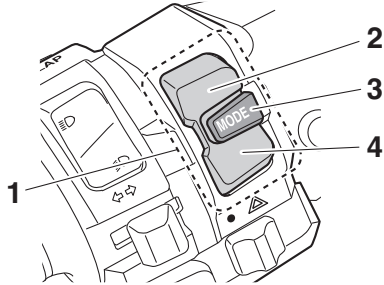

1. Mode switch "MODE"
 2. Up button
 3. Center button
 4. Down button
2. Use the mode switch up button or down button to change the selected item value (vertical scrolling is not possible).

TIP

- Under certain conditions, such as when the vehicle is in motion, the throttle grip is turned, excessive wheel slip is detected, etc., certain YRC items cannot be adjusted.
- When a YRC item is highlighted but cannot be adjusted, the YRC item box will return to black.

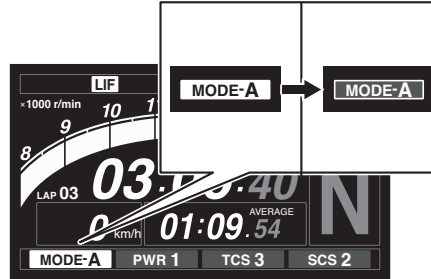

To turn off the traction control system select TCS with the center button, then push and hold the up button until TCS OFF is displayed. To turn TCS back on, select TCS ON and then press the down button (TCS will return to its previous setting).

TIP

Turning off the traction control system will turn off the SCS, LCS, and LIF systems for all YRC modes.

YRC items LCS/QS/LIF

The on/off status of YRC items LCS, QSS, and LIF is shown here. When any of these systems are registered (not set to OFF) for the currently selected YRC mode, its respective icon will appear.

When LCS is registered for the currently selected YRC mode, its icon will be grey. To activate the launch control system, press and hold the center button until the LCS icon stops flashing and turns white.

TIP

LCS, QSS, and LIF system setting levels can only be adjusted from the MENU screen.

ERS indicator "⚡" (YZF-R1M)

This icon shows the current ERS mode. (See "YRC Setting" on page 4-16 and "ERS" on page 4-19 to change the registered ERS mode or adjust ERS setting levels.)

TIP

The ERS indicator will flash should the SCU need to be reset, but this does not indicate a malfunction.

- The suspension will remain fixed at its most recent settings until the SCU is reset.
- To reset the SCU, stop the vehicle and turn the key to "OFF" then "ON".

Instrument and control functions

GPS indicator “GPS”

(CCU-equipped models)

This icon comes on when a GPS unit is synched with your vehicle.

Logging indicator “”

(CCU-equipped models)

This icon comes on when vehicle data is being recorded via the logging function.

Clock

The clock uses a 12-hour time system.

Lap timer

This stopwatch function measures and records up to forty laps. On the main screen, the lap timer shows the current lap time and lap number (indicated by the LAP mark). Use the Pass/LAP switch to mark lap times. When a lap is completed, the lap timer will show the latest lap time (marked by the LATEST indicator) for five seconds.

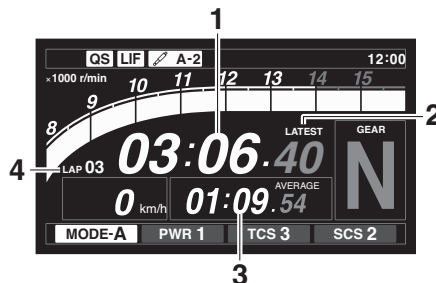

1. Lap time
2. Latest lap time indicator “LATEST”
3. Information display item
4. Lap number

To use the lap timer

1. Short push the wheel switch. The information display item will flash for five seconds.
2. While the information display item is flashing, rotate the wheel switch upward. The lap timer will flash for five seconds.
3. While the lap timer is flashing, long push the wheel switch to activate the lap timer or stop the lap timer.
4. When the lap timer has been activated, press the Pass/LAP switch to start the lap timer.

TIP

- The engine must be running to use the lap timer.
- Set the information display to FASTEST or AVERAGE for additional lap time information.
- Accessing the MENU screen will automatically stop the lap timer.
- Whenever the lap timer is stopped, the current lap will not be recorded.
- The lap time record can be viewed and reset from the MENU screen.

Warning icons

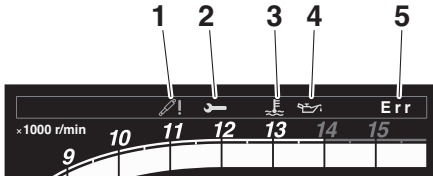

1. SCU trouble warning “”
2. Steering damper warning “”
3. Coolant temperature warning “”
4. Oil pressure warning “”
5. Error mode warning “Err”

When an error is detected, the following error-related warning icons will then be viewable.

- SCU trouble warning icon
- Steering damper warning icon
- Coolant temperature warning icon
- Oil pressure warning icon

SCU trouble warning “” (YZF-R1M)

The SCU trouble warning icon appears if a problem is detected in the front or rear suspension.

Steering damper warning “”

The steering damper warning icon appears if a problem is detected in the steering damper.

Coolant temperature warning “”

This icon comes on if the coolant temperature reaches 117 °C (242 °F) or higher. Stop the vehicle and turn off the engine. Allow the engine to cool.

ECA10022

NOTICE

Do not continue to operate the engine if it is overheating.

Oil pressure warning “”

This icon comes on when the engine oil pressure is low. When the key is first turned to ON, engine oil pressure has yet to build, so this icon will come on and stay on until the engine has been started.

ECA21210

NOTICE

If the warning light comes on when the engine is running, stop the engine immediately and check oil level. If the oil level is below the minimum

level, add sufficient oil of the recommended type to raise it up to the correct level. If the oil pressure warning light remains on even if the oil level is correct, immediately turn the engine off and have a Yamaha dealer check the vehicle.

Error mode warning “Err”

When an internal error occurs (e.g., communication with a system controller has been cut off), the error mode warning will appear as follows.

“Err” and “” indicates an ECU error.
“Err” and “” indicates an SCU error.
“Err” only indicates an HCU (hydraulic control unit) error.

TIP

- Depending on the nature of the error, the display may not function properly and YRC settings may be impossible to change. Additionally, ABS and UBS may not function properly. Use extra care when braking and have a Yamaha dealer check the vehicle immediately.

Instrument and control functions

EAU79291

MENU screen

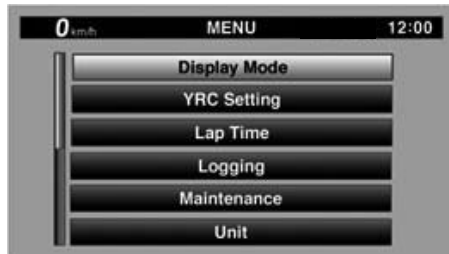

4

The MENU screen contains the following setting modules. Select a module to make related setting changes. Although some settings can be changed or reset via the main screen, the MENU screen offers access to all display and control settings.

Display	Description
Display Mode	Switch the main screen display between street and track modes.
YRC Setting	Adjust YRC settings (all models) and ERS settings (YZF-R1M).
Lap Time	View and reset lap times.
Logging	Turn vehicle information logging function on/off (CCU-equipped models).

Maintenance	View and reset three maintenance item intervals.
Unit	Set fuel consumption and distance units.
Wallpaper	Set background colors.
Shift Indicator	Turn the shift indicator on/off and adjust tachometer settings.
Display Setting	Set the multi-function display window items.
Brightness	Adjust screen brightness.
Clock	Adjust the clock.
All Reset	Return all settings to factory default settings.

MENU access and operation

The following wheel switch operations are common operations for accessing, selecting, and moving within the MENU screen and its modules.

Long push - press and hold the wheel switch for one second to access the MENU screen or exit MENU entirely.

Select - rotate the wheel switch up or down to highlight the desired module or setting item and then short push the wheel switch (briefly press the wheel switch inward) to confirm the selection.

Triangle mark - certain setting screens

have an upward pointing triangle mark item. Select the triangle mark to exit that screen and move back one screen (or long push the wheel switch to exit MENU entirely).

TIP

Should vehicle motion be detected, the screen will automatically exit MENU and change to the main screen.

“Display Mode”

There are two main screen display modes, STREET MODE and TRACK MODE.

To set the main screen display mode

1. Long push the wheel switch to enter the MENU screen.



Instrument and control functions

2. Select “Display Mode”.

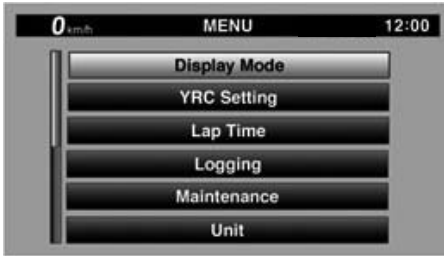

3. Select STREET MODE or TRACK MODE (or select the triangle mark to exit).



4. Long push the wheel switch to exit the MENU screen or use the wheel switch to select another module.

“YRC Setting”

This module allows you to customize the four YRC modes MODE-A, MODE-B, MODE-C, MODE-D by adjusting the setting levels (or on/off status as applicable) of YRC items PWR, TCS, SCS, LCS, QSS, and LIF. For YZF-R1M, you can select the ERS mode to be associated with each YRC mode, and also adjust the setting levels of the ERS modes.

TIP

- TCS has 9 setting levels and ERS has 6 modes.
- Whenever there are more selections (setting levels or modes) available than can be shown on the screen at one time, a scroll bar will appear to notify you that additional selections are available by scrolling.

PWR

Select PWR-1 for the most aggressive throttle response, PWR-2 and PWR-3 for smoother throttle grip/engine response, and use PWR-4 for rainy days or whenever less engine power is desir-

able.

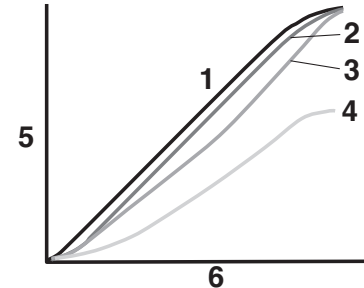

1. PWR 1
2. PWR 2
3. PWR 3
4. PWR 4
5. Throttle valve opening
6. Throttle grip operation

TCS

This model uses a variable traction control system. For each setting level, the further the vehicle is leaned over, the greater the amount of traction control (system intervention) is applied. There are 9 setting levels available. Setting level 1 applies the least amount of overall system intervention, while setting level 9 applies the greatest amount of overall traction control.

Instrument and control functions

TIP

- TCS can only be turned on or off via the main screen using the mode switch.
- When TCS has been turned off, TCS, SCS, LCS, and LIF will be set to OFF and cannot be adjusted. When TCS is turned on again, these related-traction control functions will return to their previous setting levels.

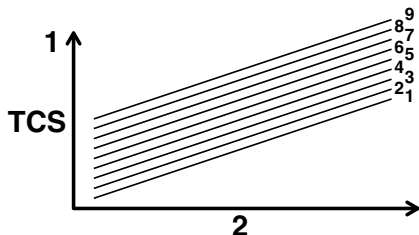

1. System intervention
2. Lean angle

SCS

SCS can be set to OFF, 1, 2, and 3. OFF turns the slide control system off, setting level 1 provides the least

amount of system intervention, and setting level 3 provides the greatest amount of system intervention.

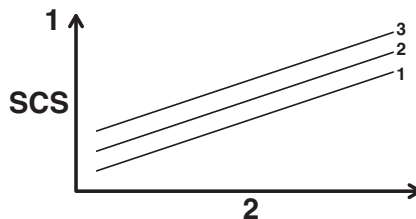

1. System intervention
2. Sideward slide

LCS

LCS can be set to 1, 2, or OFF. Setting level 2 more strongly controls power engine output, while setting level 1 applies less system intervention. OFF disables the LCS function from the selected YRC mode (the LCS icon will not appear and the launch control function cannot be activated).

When LCS has been set to level 1 or 2 for the selected YRC mode, the LCS indicator on the main screen will appear in a grey color to indicate that LCS is

available. When the launch control system has been activated (made ready for use via the mode switch), the LCS indicator will turn white.

TIP

LCS works in conjunction with the LIF system. LCS cannot be used if LIF is turned off.

QSS

QSS can be set to 1, 2, or OFF. Setting level 1 gives the fastest shifts, while setting level 2 gives slightly smoother shifts. OFF turns the system off entirely, and the clutch lever must then be used when making upshifts.

TIP

Turning the QSS on or off does not affect any other systems nor is QSS affected by the settings of any other system.

LIF

LIF can be set to 1, 2, 3, or OFF. Setting level 3 most strongly reduces wheel lift, and setting level 1 provides the least amount of system intervention. OFF

Instrument and control functions

turns LIF off and LCS will be disabled for the selected YRC mode.

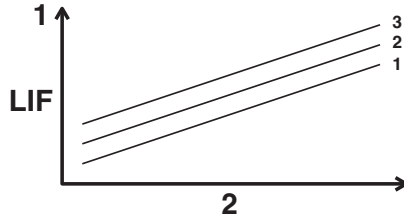

1. System intervention
2. Wheel lift

To customize a YRC mode or adjust a YRC item

1. From the MENU screen, select “YRC Setting”.



2. The “YRC Setting” screen is displayed, and the YRC mode box “YRC” is highlighted. Short push the wheel switch to enter the box and then select the YRC mode; A, B, C, D, that you want to adjust.

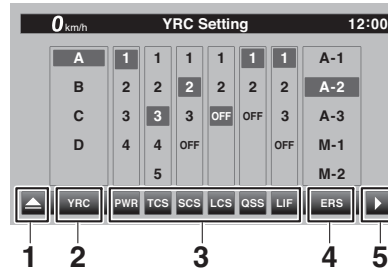

1. Triangle mark
 2. YRC mode box
 3. YRC item
 4. ERS mode (YZF-R1M)
 5. To ERS menu (YZF-R1M)
3. Select the YRC item; PWR, TCS, SCS, LCS, QSS, LIF, or ERS (YZF-R1M) that you want to adjust.

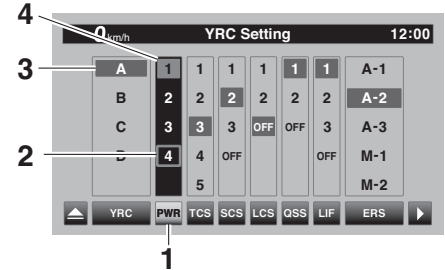

1. YRC item
2. Current level setting
3. YRC mode
4. Factory preset level

TIP

- When a YRC item is selected, the current setting level is indicated by a blue-framed square and the factory preset level is indicated in a grey box.
- Factory preset levels vary depending on the selected YRC mode.

4. To customize other YRC modes or adjust individual YRC items, repeat from step 2. When finished, select the triangle mark on the far left to return to the MENU screen; or for YZF-R1M, select the “▶”

Instrument and control functions

mark to fine tune the ERS mode settings.

ERS (YZF-R1M)

There are three automatic setting modes; A-1, A-2, and A-3. A-3 is fixed and cannot be adjusted. A-1 and A-2 can be adjusted to within a -5 to +5 offset of their factory preset settings.

There are three manual setting modes; M-1, M-2, and M-3. When a manual mode is selected, the SCU does not actively adjust the suspension compression and rebound damping forces. Manual mode suspension settings are adjustable to 32 levels.

TIP

- A-1 and M-1 are preset for track use with racing slick tires.
- A-2 and M-2 are preset for track use with street tires.
- A-3 and M-3 are preset for street use with street tires.
- Spring preload is manually adjusted. (See pages 4-40 and 4-42.)

To adjust the ERS mode settings

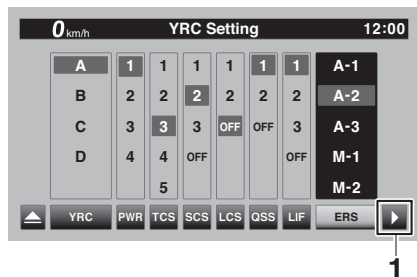

1. To ERS menu

1. Select the “▶” mark located to the right of ERS.
2. The display will change to the front and rear suspension setting screen and the ERS mode selection box “SETTING” is highlighted. Short push the wheel switch to enter the box and select the ERS mode A-1, A-2, M-1, M-2, M-3 that you want to adjust.

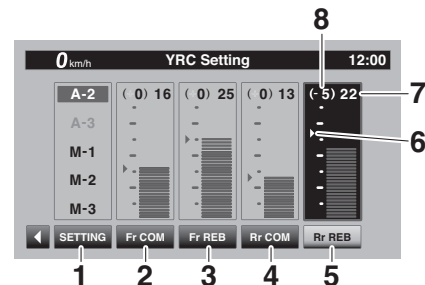

1. ERS mode selection box “SETTING”
2. Front compression damping force
3. Front rebound damping force
4. Rear compression damping force
5. Rear rebound damping force
6. Factory preset level
7. Current level setting
8. Offset level

3. Select the suspension item, Fr COM, Fr REB, Rr COM, Rr REB, that you want to adjust.

TIP

- To decrease the damping force and soften the suspension, increase the setting level.
- To increase the damping force and harden the suspension, decrease the setting level.

Instrument and control functions

- For A-1 and A-2, a number indicated in () means how many levels are changed from its factory preset level.
- When a suspension setting item in A-1 or A-2 is offset, the same suspension item will be similarly offset in the other automatic mode (offset values for the same item are automatically linked).
- M-1, M-2, M-3 are not linked and can be independently set.

4. To adjust other ERS mode suspension settings, repeat from step 2. When finished, select the “◀” mark located on the left to return to the main “YRC Setting” menu.

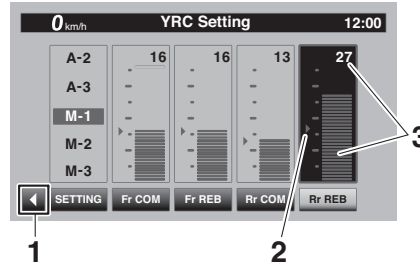

1. To YRC Setting menu
2. Factory preset level
3. Current level setting

“Lap Time”

This module allows you to view and delete the lap time record. The fastest lap and the average lap time stored in the lap time record are displayed at the top of the screen. Use the wheel switch to scroll and see all lap times. The top three fastest laps will be highlighted in silver. Up to 40 laps can be stored in memory. If more than 40 laps are recorded, the oldest laps (starting from lap 1) will be overwritten.

This module has two options.

“Display” allows you to view the lap time record.

“Reset” allows you to delete the lap time record data.

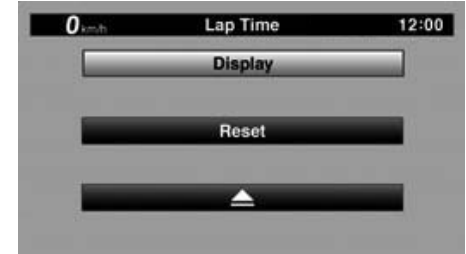

Use the wheel switch to select “Display” and view the lap record.

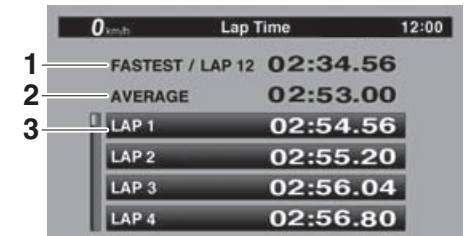

1. Fastest lap
2. Average lap time
3. Lap time record

Instrument and control functions

To reset the lap time record data

1. When “Lap Time” is selected, both “Display” and “Reset” are displayed.

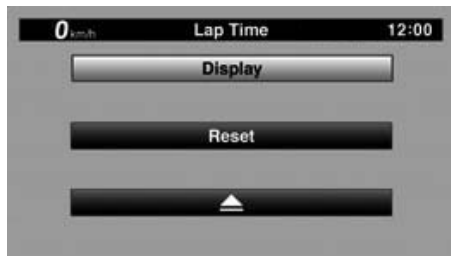

2. Select “Reset”.

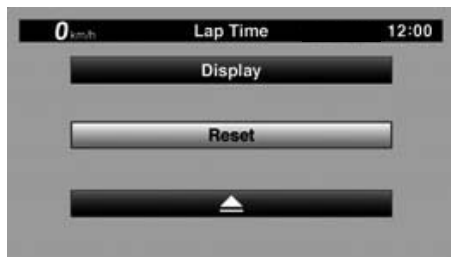

3. Select YES to delete all lap time data. (Select NO to exit and return to the previous screen without resetting the lap record.)

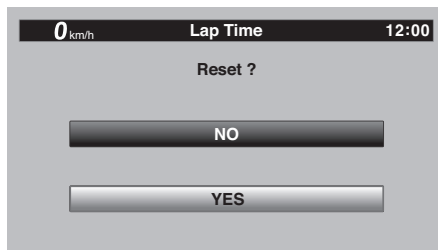

“Logging” (for CCU-equipped models)

Vehicle and riding information can be recorded (logged) and this data can be accessed with a smart device (see “CCU” on page 4-38).

To start and stop logging

1. From the MENU screen, select “Logging”.



TIP

If a CCU is not installed or the CCU is not properly connected, then the “Logging” module cannot be selected.

2. Select START to start logging.

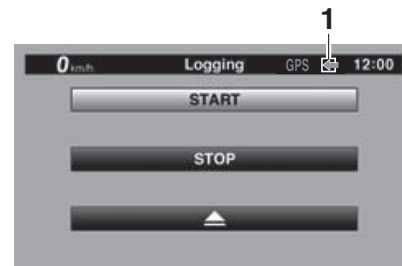

1. Logging indicator

3. To stop the “Logging” function, select STOP or turn the vehicle off.

Instrument and control functions

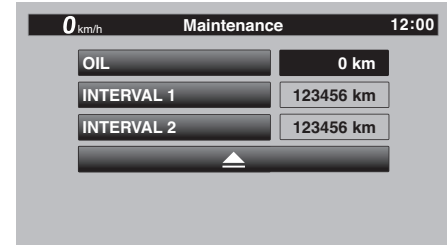

“Maintenance”

This module allows you to record distance traveled between engine oil changes (use the OIL item), and for two other items of your choice (use INTERVAL 1 and INTERVAL 2).

To reset a maintenance item

1. From the MENU screen, select “Maintenance”.

2. Select the item you want to reset.



3. Long push the wheel switch to reset the item.

TIP

Maintenance item names cannot be changed.

“Unit”

This module allows you to switch the display between kilometers and miles. When using kilometers, the fuel consumption units can be changed between km/L or L/100km. When using miles, MPG will be available.

To set the distance or fuel consumption units

1. From the MENU screen, select “Unit”.

Instrument and control functions

4

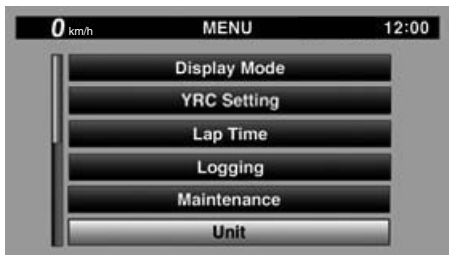

2. “km or mile” and “km/L or L/100km” are displayed.

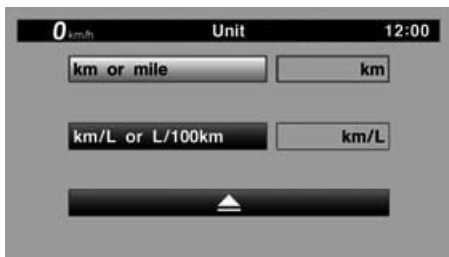

3. Select the distance or consumption unit item you want to adjust.

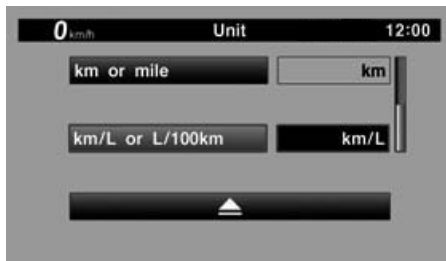

4. Select the units you want to use.

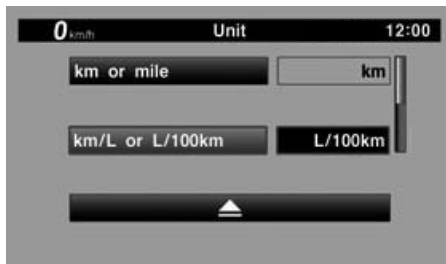

5. Select the triangle symbol to exit.

“Wallpaper”

This module allows you to individually set the STREET MODE and TRACK MODE display background colors to black or white for both day and night settings. A photo sensor equipped in

the instrument panel detects lighting conditions and will automatically change the display between its day and night settings. The photo sensor also controls a subtle automatic brightness adjustment function within both day and night modes to suit ambient light conditions.



1. Photo sensor

To set the wallpaper

1. From the MENU screen, select “Wallpaper”.

Instrument and control functions



2. Select the mode you want to adjust (select DAY for daytime display settings or NIGHT for nighttime display settings).
3. Select the background color (select BLACK for a black background or WHITE for a white background).

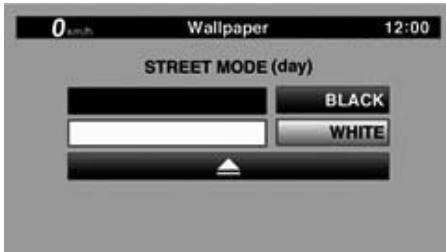

4. Select the triangle symbol to exit.
5. To set another background color,

repeat from step 2 or select the triangle symbol to exit this module.



“Shift indicator”

The shift indicator module contains the following items.

Display	Description
Shift IND Setting	Set the shift indicator pattern to “ON”, “Flash”, or “OFF” and adjust at what r/min the indicator will come on and go off.
Shift IND Brightness	Adjust the brightness of the shift indicator.
Tach IND Setting	Set the tachometer color display to “ON” or “OFF” and adjust at what r/min the tachometer will be green and orange.
Peak Rev IND Setting	Set the tachometer peak rev indicator to “ON” or “OFF”.

To make setting changes

1. Select “Shift IND Setting”.



2. Select “IND Mode”.

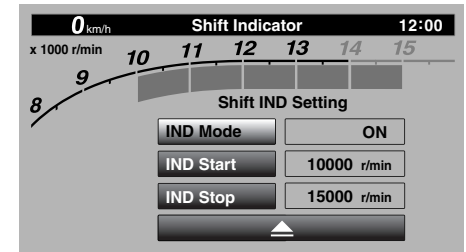

3. Select “ON” to have the indicator light steadily, “OFF” to turn the indicator off, or “Flash” to have the shift indicator flash when the indicator start threshold has been reached.

Instrument and control functions

4

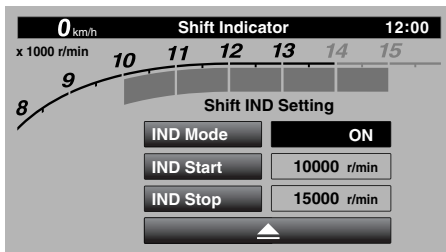

4. Select “IND Start”.

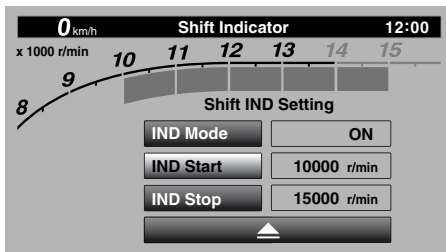

5. Rotate the wheel switch to adjust the r/min at which the shift timing indicator light will come on. “IND Start” operational range is 8000–14800 r/min.

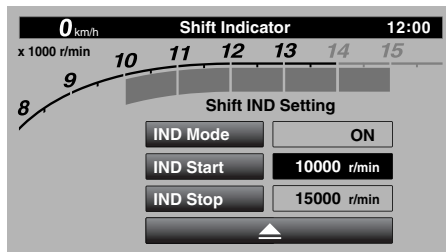

6. Select “IND Stop” then rotate the wheel switch to adjust the r/min at which the shift timing indicator will go off. “IND Stop” operational range is 8500–15000 r/min.

TIP

The blue area on the tachometer indicates the currently set operational range of the shift indicator light.

“Shift IND Brightness”

The shift timing indicator light has six brightness levels.



Select “Shift IND Brightness”, then use the wheel switch to adjust the setting. Short push the wheel switch to confirm the setting and exit.

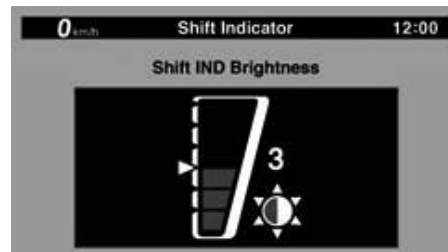

“Tach IND Setting”

This module allows you to turn the tachometer color display on or off. When turned off, the tachometer will display all r/min levels below the red zone in

Instrument and control functions

black or white (depending on wallpaper settings). When turned on, the mid and mid-to-high r/min zones can be set to come on in green and then orange colors.



1. Select "Tach IND Setting".

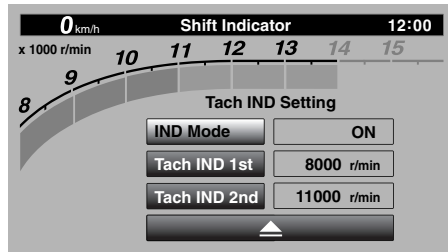

2. Select "IND Mode".

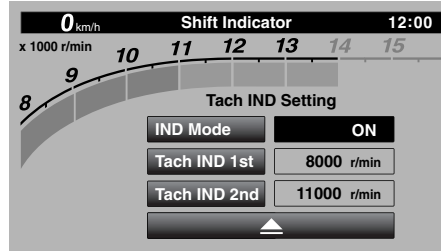

3. Select ON to turn the tachometer color display mode on (or select OFF to turn this function off).
4. Select "Tach IND 1st" to set the green zone starting r/min.

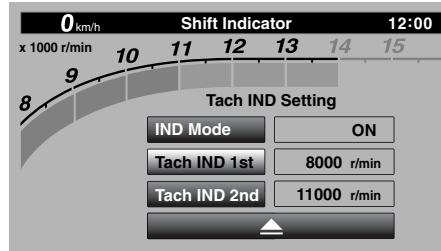

5. Set the starting r/min by rotating and then short pushing the wheel button. All r/min above this value up to the "Tach IND 2nd" setting

value (or the 14000 r/min red zone), will be displayed in green.

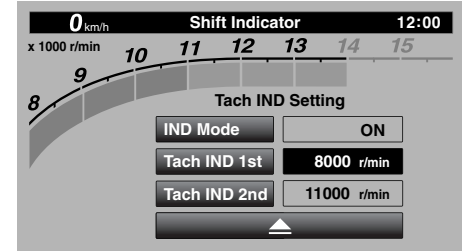

TIP

Green bar start setting range: 8000–10000 r/min.

6. Select "Tach IND 2nd".

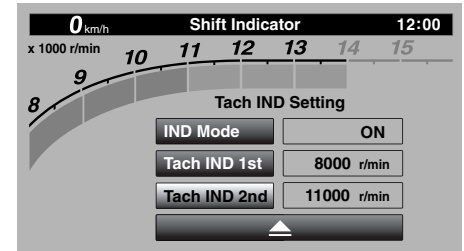

7. Set the orange color starting r/min by rotating and then short pushing

Instrument and control functions

the wheel switch. All r/min above this figure until the 14000 r/min red zone, will be displayed in orange.

TIP

Orange bar start setting range: 8000–14000 r/min.

4

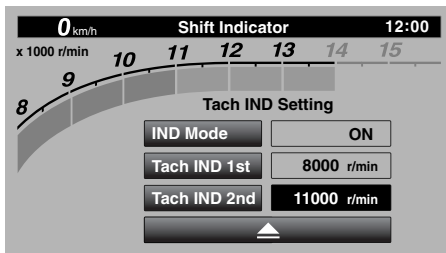

8. Select the triangle symbol to exit.

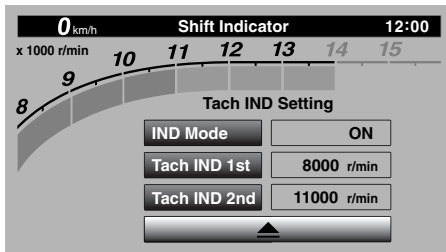

“Peak Rev IND Setting”

This module allows you to turn the revolution peak hold indicator on or off.

1. Select “Peak Rev IND Setting”.



2. Select “IND Mode” and then select ON (to turn on the indicator) or OFF (to turn off the indicator).

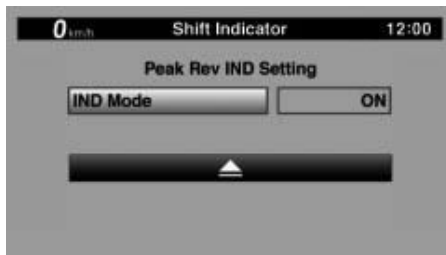

3. Select the triangle symbol to exit.

“Display Setting”

This module allows you to set how the information display items (like TRIP-1, ODO, C. TEMP, etc.) are grouped on the main screen. There are four display groups.

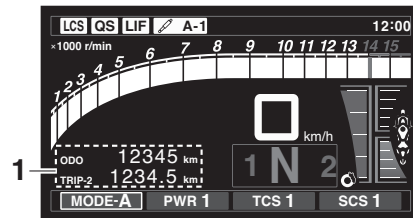

1. Information display item (STREET MODE)

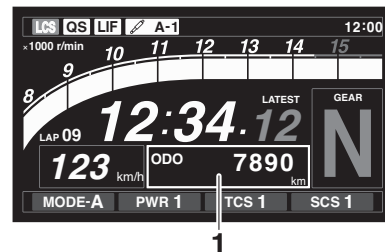

1. Information display item (TRACK MODE)

Instrument and control functions

To set the display groups

1. Select "Display Setting".

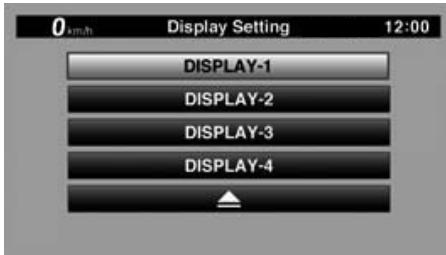

2. DISPLAY-1, DISPLAY-2, DISPLAY-3 and DISPLAY-4 are displayed.
3. For example, let's select DISPLAY-1. STREET MODE 1-1, STREET MODE 1-2, and TRACK MODE are displayed.

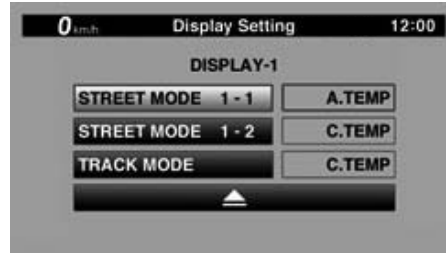

4. Select STREET MODE 1-1.

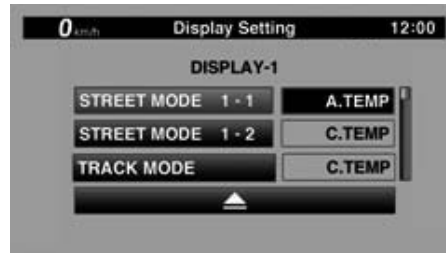

5. Select the desired information display item with the wheel switch.

TIP

The information display items which can be selected are:

- A.TEMP: air temperature
- C.TEMP: coolant temperature
- TRIP-1: tripmeter 1

TRIP-2: tripmeter 2

ODO: odometer

FUEL CON: the amount of fuel consumed

FUEL AVG: average fuel consumption

CRNT FUEL: current fuel consumption

6. Select STREET MODE 1-2 or TRACK MODE to set the remaining DISPLAY-1 group items.

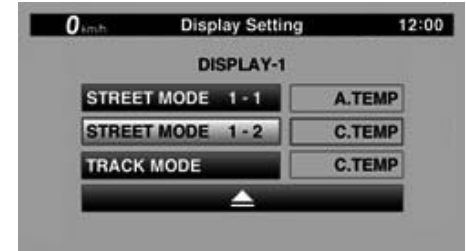

7. Select the triangle symbol to exit.
To set the other display groups, repeat from step 3.

"Brightness"

This module allows you to adjust the general brightness level of the display screen.

Instrument and control functions

To set the brightness

1. Select "Brightness".



2. Select the desired brightness level by rotating the wheel switch, and then short push the wheel switch to fix the setting.

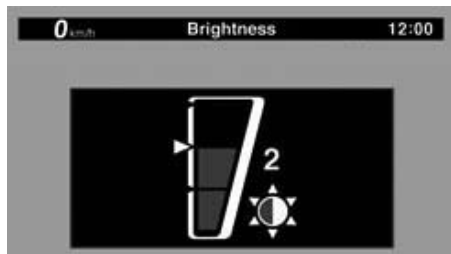

"Clock"

This module allows you to set the clock.

To set the clock

1. From the MENU screen, select "Clock".



2. When "Clock" is selected, the hours figure will be highlighted.



3. Set the hour by rotating and then short push the wheel switch.



4. The minutes figure will become highlighted.



5. Set the minutes figure by rotating and then short push the wheel switch.



6. Short push the wheel switch again to exit and go back to the MENU screen.

“All Reset”

This module resets everything, except the odometer and clock, to its factory preset or default setting.

Select YES to reset all items. After selecting YES, all items will be reset and the screen will automatically return to the MENU screen.

Clutch lever

EAU12822

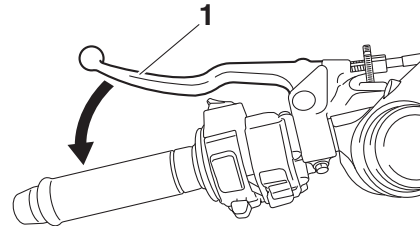

1. Clutch lever

The clutch lever is located on the left side of the handlebar. To disengage the clutch, pull the lever toward the handlebar grip. To engage the clutch, release the lever. The lever should be pulled rapidly and released slowly for smooth clutch operation.

The clutch lever is equipped with a clutch switch, which is part of the ignition circuit cut-off system. (See page 4-47.)

Shift pedal

EAU67010

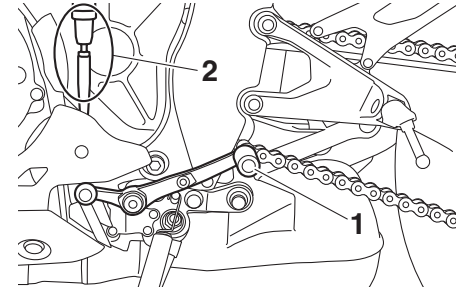

1. Shift pedal
2. Shift switch

The shift pedal is located on the left side of the motorcycle and is used in combination with the clutch lever when shifting the gears of the 6-speed constant-mesh transmission.

When the quick-shift system is turned on, the shift switch senses shift pedal movement and allows for upshifting without operating the clutch lever. See QSS on page 4-17 for more information.

Instrument and control functions

EAU67033

Brake lever

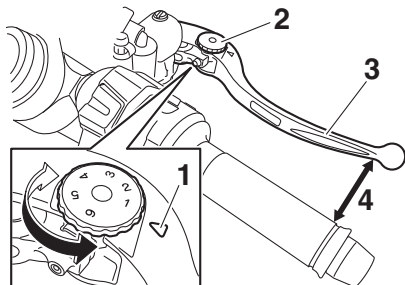

1. “△” mark
2. Brake lever position adjusting dial
3. Brake lever
4. Distance between brake lever and handlebar grip

The brake lever is located on the right side of the handlebar. To apply the front brake, pull the lever toward the throttle grip.

This model is equipped with a variable unified brake system (UBS).

When pulling the brake lever, the front brake and a portion of the rear brake are applied. For full braking performance, apply both the brake lever and brake pedal simultaneously.

TIP
See **Brake system** for more information on how the UBS and ABS systems work.

The brake lever is equipped with a brake lever position adjusting dial. To adjust the distance between the brake lever and the throttle grip, turn the adjusting dial while holding the lever pushed away from the throttle grip. Make sure that the appropriate setting on the adjusting dial is aligned with the “△” mark on the brake lever.

EAU12944

Brake pedal

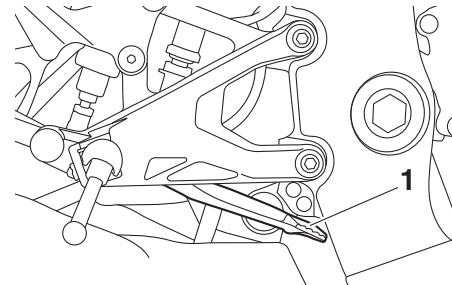

1. Brake pedal

The brake pedal is located on the right side of the motorcycle. To apply the rear brake, press down on the brake pedal.

Brake system

This model is equipped with an integrated anti-lock brake system (ABS) and a variable unified brake system (UBS).

Regarding ABS, operate the brakes as you would conventional brakes. If the ABS is activated, a pulsating sensation may be felt at the brake lever or brake pedal. In this situation, continue to apply the brakes and let the ABS work; do not “pump” the brakes as this will reduce braking effectiveness.

EAU67041

WARNING

Always keep a sufficient distance from the vehicle ahead to match the riding speed even with ABS.

- The ABS performs best with long braking distances.
- On certain surfaces, such as rough or gravel roads, the braking distance may be longer with the ABS than without.

EWA16051

The ABS and UBS hydraulic control unit is monitored by the ABS ECU, which will revert the system to conven-

tional braking if a malfunction occurs.

TIP

- The ABS performs a self-diagnosis test when the vehicle is started and reaches a speed of 10 km/h (6 mi/h). During this test, a “clicking” noise may be audible from the hydraulic control unit, and a vibration may be felt at the brake lever or pedal, but this is normal.
- This ABS has a test mode which allows the owner to experience the pulsation at the brake lever or brake pedal when the ABS is operating. However, special tools are required, so please consult your Yamaha dealer.

ECA20100

NOTICE

Be careful not to damage the wheel sensor or wheel sensor rotor; otherwise, improper performance of the ABS will result.

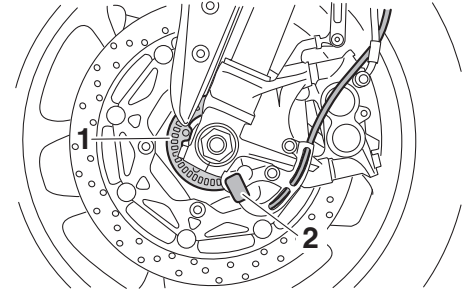

1. Front wheel sensor rotor
2. Front wheel sensor

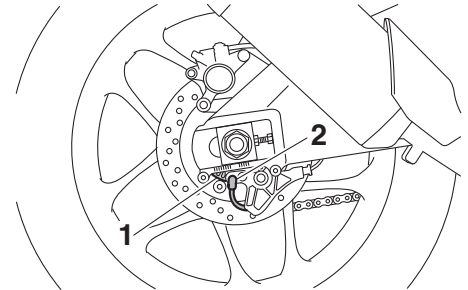

1. Rear wheel sensor rotor
2. Rear wheel sensor

Regarding variable UBS, operating the brake lever will generate corresponding brake pressure at the front brake and to a variable degree, the rear brake. The

Instrument and control functions

amount of rear wheel braking force to be applied by the UBS is based on vehicle attitude and lean angle. However, operating only the brake pedal will not generate any brake pressure at the front brake.

For full braking performance, apply both the brake lever and brake pedal simultaneously.

When both the brake lever and the brake pedal are applied simultaneously, the UBS will control the distribution of braking force between the two wheels.

TIP

- The UBS does not function until the vehicle starts moving.
- After coming to a stop while applying the brake lever, the UBS is still enabled. As further squeezing of the brake lever will not increase the braking power of the rear brake, apply the rear brake should further braking power be necessary (such as when parking on a slope).

The UBS disables after the brake lever is released.

When the vehicle starts moving, the UBS is re-enabled.

Fuel tank cap

EAU13075

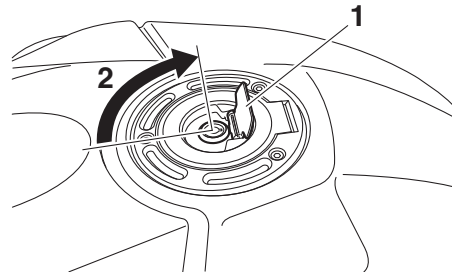

1. Fuel tank cap lock cover
2. Unlock.

To open the fuel tank cap

Open the fuel tank cap lock cover, insert the key into the lock, and then turn it 1/4 turn clockwise. The lock will be released and the fuel tank cap can be opened.

To close the fuel tank cap

1. Push the fuel tank cap into position with the key inserted in the lock.
2. Turn the key counterclockwise to the original position, remove it, and then close the lock cover.

TIP

The fuel tank cap cannot be closed unless the key is in the lock. In addition, the key cannot be removed if the cap is not properly closed and locked.

EWA11092

WARNING

Make sure that the fuel tank cap is properly closed after filling fuel. Leaking fuel is a fire hazard.

Fuel

Make sure there is sufficient gasoline in the tank.

EAU13222

EWA10882

WARNING

Gasoline and gasoline vapors are extremely flammable. To avoid fires and explosions and to reduce the risk of injury when refueling, follow these instructions.

1. Before refueling, turn off the engine and be sure that no one is sitting on the vehicle. Never refuel while smoking, or while in the vicinity of sparks, open flames, or other sources of ignition such as the pilot lights of water heaters and clothes dryers.
2. Do not overfill the fuel tank. When refueling, be sure to insert the pump nozzle into the fuel tank filler hole. Stop filling when the fuel reaches the bottom of the filler tube. Because fuel expands when it heats up, heat from the engine or the sun can cause fuel to spill out of the fuel tank.

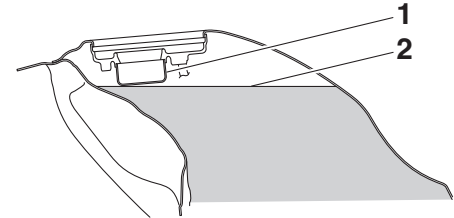

1. Fuel tank filler tube
2. Maximum fuel level

3. Wipe up any spilled fuel immediately. **NOTICE: Immediately wipe off spilled fuel with a clean, dry, soft cloth, since fuel may deteriorate painted surfaces or plastic parts.**^[ECA10072]
4. Be sure to securely close the fuel tank cap.

EWA15152

WARNING

Gasoline is poisonous and can cause injury or death. Handle gasoline with care. Never siphon gasoline by mouth. If you should swallow some gasoline or inhale a lot of gasoline vapor, or get some gasoline in

Instrument and control functions

your eyes, see your doctor immediately. If gasoline spills on your skin, wash with soap and water. If gasoline spills on your clothing, change your clothes.

EAU75320



hol containing ethanol and that containing methanol. Gasohol containing ethanol can be used if the ethanol content does not exceed 10% (E10). Gasohol containing methanol is not recommended by Yamaha because it can cause damage to the fuel system or vehicle performance problems.

4

Recommended fuel:

Premium unleaded gasoline (Gasohol [E10] acceptable)

Fuel tank capacity:

17 L (4.5 US gal, 3.7 Imp.gal)

Fuel reserve amount (when the fuel level warning light comes on):

3.0 L (0.79 US gal, 0.66 Imp.gal)

ECA11401

NOTICE

Use only unleaded gasoline. The use of leaded gasoline will cause severe damage to internal engine parts, such as the valves and piston rings, as well as to the exhaust system.

TIP

- This mark identifies the recommended fuel for this vehicle as specified by European regulation (EN228).
- Check that gasoline nozzle has the same identifier when fueling.

Your Yamaha engine has been designed to use premium unleaded gasoline with a research octane number of 95 or higher. If knocking (or pinging) occurs, use a gasoline of a different brand. Use of unleaded fuel will extend spark plug life and reduce maintenance costs.

Gasohol

There are two types of gasohol: gaso-

Fuel tank breather hose and overflow hose

EAU58081

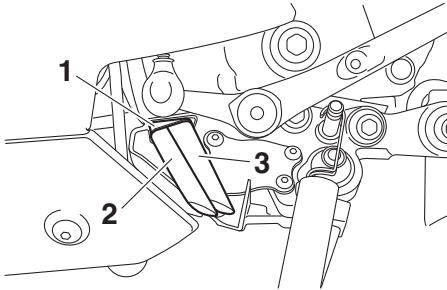

1. Clamp
2. Fuel tank overflow hose
3. Fuel tank breather hose

Before operating the motorcycle:

- Check each hose connection.
- Check each hose for cracks or damage, and replace if necessary.
- Make sure that the end of each hose is not blocked, and clean if necessary.
- Make sure that the end of each hose is positioned outside of the cowling.
- Make sure that each hose is routed through the clamp or guide.

Catalytic converter

EAU13434

This model is equipped with a catalytic converter in the exhaust system.

EWA10863

⚠ WARNING

The exhaust system is hot after operation. To prevent a fire hazard or burns:

- Do not park the vehicle near possible fire hazards such as grass or other materials that easily burn.
- Park the vehicle in a place where pedestrians or children are not likely to touch the hot exhaust system.
- Make sure that the exhaust system has cooled down before doing any maintenance work.
- Do not allow the engine to idle more than a few minutes. Long idling can cause a build-up of heat.

ECA10702

NOTICE

Use only unleaded gasoline. The use of leaded gasoline will cause unre-

pairable damage to the catalytic converter.

Instrument and control functions

EAU66570

Seats

Passenger seat

To remove the passenger seat

1. Insert the key into the seat lock, and then turn it clockwise.

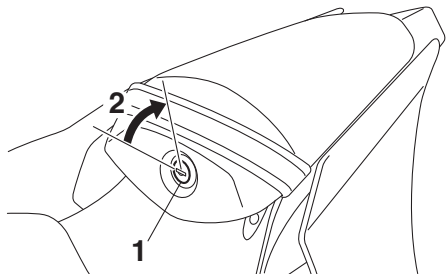

1. Seat lock
2. Unlock.

2. Lift the front of the passenger seat and pull it forward.

To install the passenger seat

1. Insert the projection on the rear of the passenger seat into the seat holder as shown, and then push the front of the seat down to lock it in place.

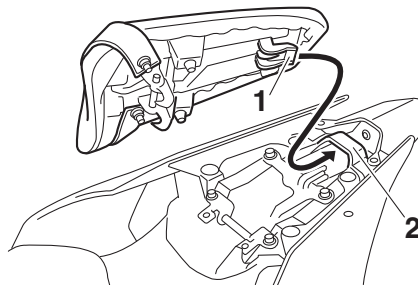

1. Projection
2. Seat holder

2. Remove the key.

Rider seat

To remove the rider seat

1. Remove the passenger seat.
2. Pull up the corners on the rear of the rider seat as shown, remove the bolts with the hexagon wrench located under the passenger seat, and then pull the seat off.

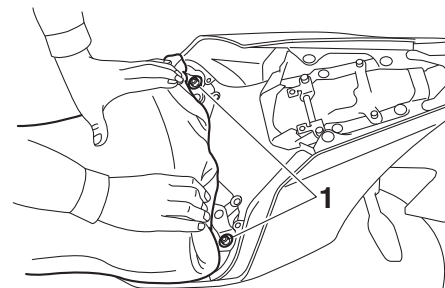

1. Bolt

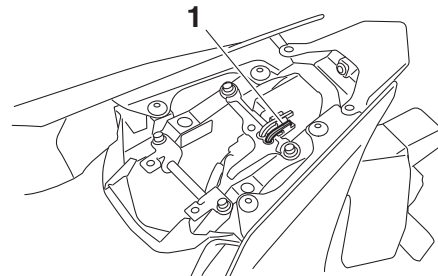

1. Hexagon wrench

To install the rider seat

1. Insert the projections into the seat holders as shown, then place the seat in the original position.

EAU67156

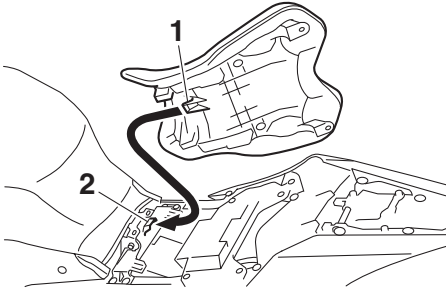

1. Projection
2. Seat holder

2. Install the bolts with the hexagon wrench.
3. Insert the hexagon wrench back into its holder.
4. Install the passenger seat.

TIP

Make sure that the seats are properly secured before riding.

CCU (for equipped models)

The CCU (communication control unit) connects to the vehicle's CAN (controller area network) and has a GPS receiver to enable the recording of vehicle and riding data (see "Logging" on page 4-21). Logging data and YRC setting data can be accessed when a smartphone or tablet is connected to the CCU wireless network.

TIP

From the Google© or Apple© application store, download the "Y-TRAC" application to make use of the logging data and the "YRC Setting" application to remotely adjust the YRC settings.

To connect to the CCU wireless network

1. Remove the screws, move the GPS receiver, and then remove the seat cover as shown.

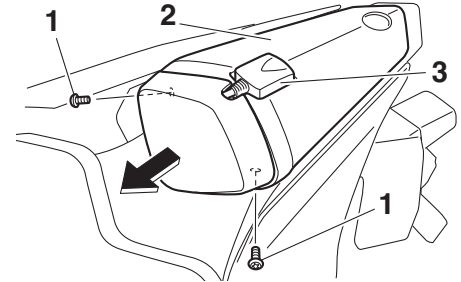

1. Screw
2. Seat cover
3. GPS receiver

2. Note down the CCU serial number.

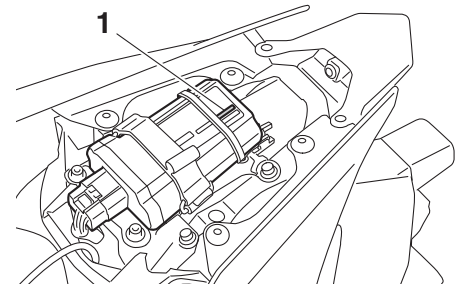

1. CCU serial number

3. Turn the key to "ON" and approach the vehicle with a wireless capable

Instrument and control functions

smartphone or tablet.

4. Connect to the wireless network “YAMAHA MOTOR CCU” by inputting the CCU serial number as the password.
5. Install the seat cover and GPS receiver to the original position, and then install the screws.

4

TIP

Since all CCU-equipped models put out a similarly named wireless network, have only one vehicle turned on at a time to avoid confusion.

Document storage

EAU66920

direct sunlight.

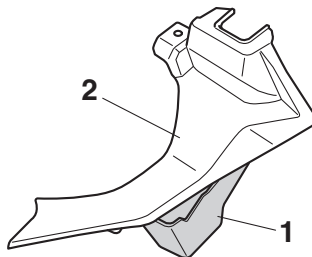

1. Document storage space
2. Panel C

A document storage space is located under panel C. (See page 7-9.)

When storing the owner's manual or vehicle registration and insurance documents in the document storage space, be sure to wrap them in a plastic bag so that they will not get wet. When washing the vehicle, avoid letting water enter the document storage space.

ECA22540

NOTICE

Do not place heat-sensitive items in the document storage space. This space can get hot when the engine is running or when the vehicle is in

Rear view mirrors

The rear view mirrors of this vehicle can be folded forward for parking in narrow spaces. Fold the mirrors back to their original position before riding.

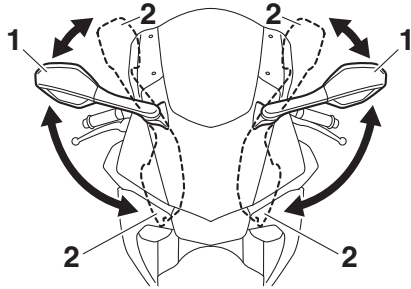

1. Riding position
2. Parking position

WARNING

Be sure to fold the rear view mirrors back to their original position before riding.

EAU47261

EWA14372

Adjusting the front fork

NOTICE

- Use extra care to avoid scratching the gold-anodized finish when making suspension adjustments.
- To avoid damaging the suspension's internal mechanisms, do not attempt to turn beyond the maximum or minimum settings.

For YZF-R1

This model is equipped with adjustable suspension. The spring preload, rebound damping force, and compression damping force of each leg can be adjusted.

WARNING

Always adjust both fork legs equally, otherwise poor handling and loss of stability may result.

Spring preload

To increase the spring preload and thereby harden the suspension, turn

EAU66474

ECA22471

the adjusting nut on each fork in direction (a). To decrease the spring preload and thereby soften the suspension, turn the adjusting nut on each fork in direction (b).

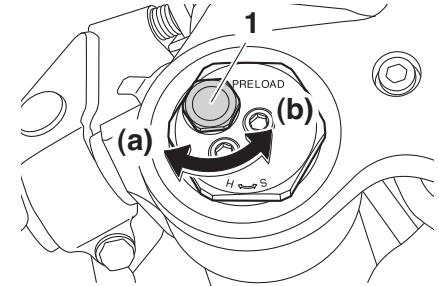

1. Spring preload adjusting nut

Spring preload setting:

Minimum (soft):

0 turn(s) in direction (a)*

Standard:

9 turn(s) in direction (a)*

Maximum (hard):

15 turn(s) in direction (a)*

* With the adjusting nut fully turned in direction (b)

EWA10181

Rebound damping force

To increase the rebound damping force and thereby harden the rebound damp-

Instrument and control functions

ing, turn the adjusting bolt on each fork leg in direction (a). To decrease the rebound damping force and thereby soften the rebound damping, turn the adjusting bolt on each fork leg in direction (b).

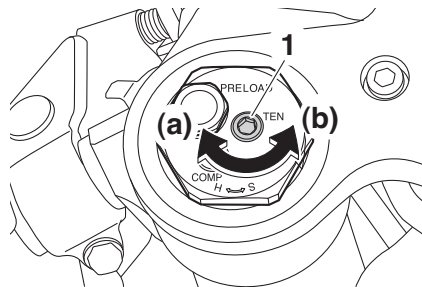

1. Rebound damping force adjusting bolt

Rebound damping setting:

Minimum (soft):

14 click(s) in direction (b)*

Standard:

7 click(s) in direction (b)*

Maximum (hard):

0 click(s) in direction (b)*

* With the adjusting bolt fully turned in direction (a)

force and thereby harden the compression damping, turn the adjusting bolt on each fork leg in direction (a). To decrease the compression damping force and thereby soften the compression damping, turn the adjusting bolt on each fork leg in direction (b).

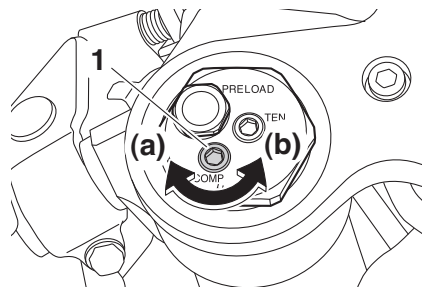

1. Compression damping force adjusting bolt

Compression damping setting:

Minimum (soft):

23 click(s) in direction (b)*

Standard:

17 click(s) in direction (b)*

Maximum (hard):

0 click(s) in direction (b)*

* With the adjusting bolt fully turned in direction (a)

Compression damping force

To increase the compression damping

TIP

- Although the total number of clicks of a damping force adjusting mechanism may not exactly match the above specifications due to small differences in production, the actual number of clicks always represents the entire adjusting range. To obtain a precise adjustment, check the number of clicks and modify the minimum and standard specifications as necessary.
- When turning the damping force adjusting bolt in direction (a), the 0 click position and the 1 click position may be the same.

For YZF-R1M

This model is equipped with ÖHLINS electronic racing suspension. The compression and rebound damping forces are electronically adjusted. (See ERS on page 4-19.)

Spring preload

The spring preload adjustment is performed manually.

1. Turn the vehicle off.

Adjusting the shock absorber assembly

WARNING

This shock absorber assembly contains highly pressurized nitrogen gas. Read and understand the following information before handling the shock absorber assembly.

- Do not tamper with or attempt to open the cylinder assembly.
- Do not subject the shock absorber assembly to an open flame or other high heat source. This may cause the unit to explode due to excessive gas pressure.
- Do not deform or damage the cylinder in any way. Cylinder damage will result in poor damping performance.
- Do not dispose of a damaged or worn-out shock absorber assembly yourself. Take the shock absorber assembly to a Yamaha dealer for any service.

2. Slide the rubber cover back at each coupler.
3. Remove the coupler on each front fork. **NOTICE: To prevent damaging the couplers, do not use sharp tools or excessive force.**^[ECA22770]

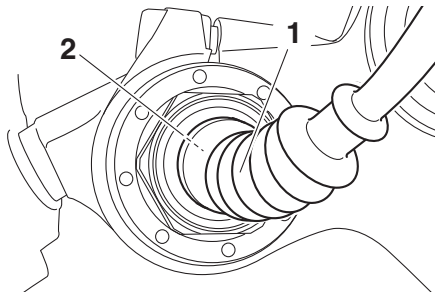

1. Rubber cover
2. Coupler

4. To increase the spring preload and thereby harden the suspension, turn the adjusting bolt on each fork leg in direction (a). To decrease the spring preload and thereby soften the suspension, turn the adjusting bolt on each fork leg in direction (b).

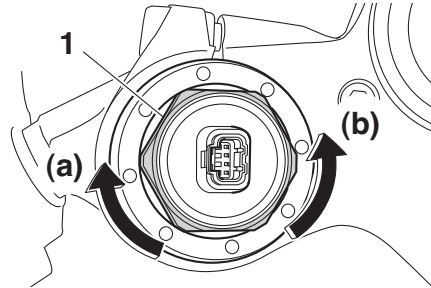

1. Spring preload adjusting bolt

Spring preload setting:

Minimum (soft):

0 turn(s) in direction (a)*

Standard:

5 turn(s) in direction (a)*

Maximum (hard):

15 turn(s) in direction (a)*

* With the adjusting nut fully turned in direction (b)

5. Attach the coupler on each fork.
6. Slide the rubber cover to the original position.

Instrument and control functions

ECA10102

NOTICE

To avoid damaging the mechanism, do not attempt to turn beyond the maximum or minimum settings.

For YZF-R1:

This model is equipped with adjustable suspension. The spring preload, rebound damping force, fast compression damping force, and slow compression damping force can be adjusted.

Spring preload

1. Loosen the locknut.
2. To increase the spring preload and thereby harden the suspension, turn the adjusting ring in direction (a). To decrease the spring preload and thereby soften the suspension, turn the adjusting ring in direction (b).

The spring preload setting is determined by measuring distance A. The longer distance A is, the higher the spring preload; the shorter distance A is, the lower the spring

preload.

- Use the special wrench included in the owner's tool kit to make the adjustment.

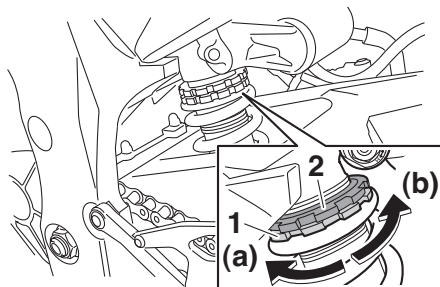

1. Spring preload adjusting ring
2. Locknut

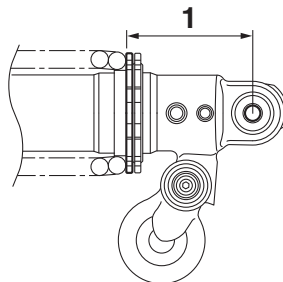

1. Distance A

Spring preload:

Minimum (soft):

Distance A = 77.5 mm (3.05 in)

Standard:

Distance A = 79.0 mm (3.11 in)

Maximum (hard):

Distance A = 85.5 mm (3.37 in)

3. Tighten the locknut to the specified torque. **NOTICE: Always tighten the locknut against the adjusting ring, and then tighten the locknut to the specified torque.**^[ECA22760]

Tightening torque:

Locknut:

25 N·m (2.5 kgf·m, 18 lb·ft)

Rebound damping force

To increase the rebound damping force and thereby harden the rebound damping, turn the adjusting screw in direction (a). To decrease the rebound damping force and thereby soften the rebound damping, turn the adjusting screw in direction (b).

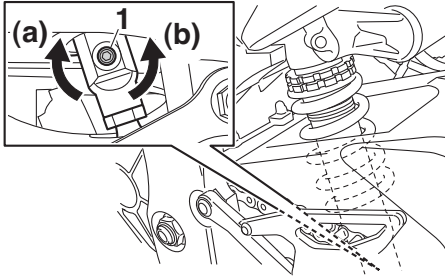

1. Rebound damping force adjusting screw

Rebound damping setting:

Minimum (soft):

23 click(s) in direction (b)*

Standard:

12 click(s) in direction (b)*

Maximum (hard):

0 click(s) in direction (b)*

* With the adjusting screw fully turned in direction (a)

Compression damping force

Fast compression damping force

To increase the compression damping force and thereby harden the fast compression damping, turn the adjusting bolt in direction (a). To decrease the compression damping force and there-

by softening the compression damping, turn the adjusting bolt in direction (b).

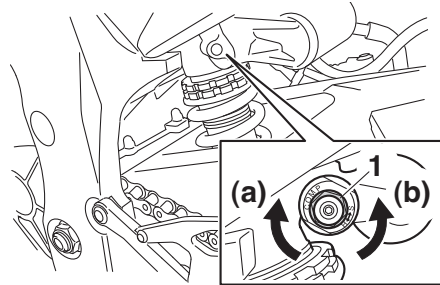

1. Fast compression damping force adjusting bolt

Fast compression damping setting

Minimum (soft):

5.5 turn(s) in direction (b)*

Standard:

3 turn(s) in direction (b)*

Maximum (hard):

0 turn(s) in direction (b)*

* With the adjusting bolt fully turned in direction (a)

Slow compression damping force

To increase the compression damping force and thereby harden the slow compression damping, turn the adjusting screw in direction (a). To decrease

the compression damping force and thereby soften the compression damping, turn the adjusting screw in direction (b).

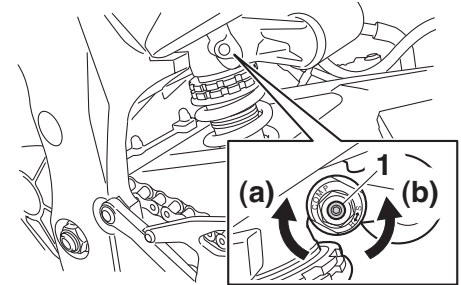

1. Slow compression damping force adjusting screw

Slow compression damping setting

Minimum (soft):

18 click(s) in direction (b)*

Standard:

10 click(s) in direction (b)*

Maximum (hard):

0 click(s) in direction (b)*

* With the adjusting screw fully turned in direction (a)

TIP

- Although the total number of clicks of a damping force adjusting mechanism may not exactly match

Instrument and control functions

4

the above specifications due to small differences in production, the actual number of clicks always represents the entire adjusting range. To obtain a precise adjustment, check the number of clicks and modify the minimum and standard specifications as necessary.

- When turning the damping force adjusting bolt in direction (a), the 0 click position and the 1 click position may be the same.

For YZF-R1M:

This model is equipped with ÖHLINS electronic racing suspension.

Compression damping force and rebound damping force

The compression and rebound damping forces are electronically controlled and can be adjusted from the MENU screen. See ERS on page 4-19 for information on how to adjust these settings.

Spring preload

The spring preload adjustment is per-

formed manually.

ECA10102

NOTICE

To avoid damaging the mechanism, do not attempt to turn beyond the maximum or minimum settings.

1. Loosen the locknut.
2. To increase the spring preload and thereby harden the suspension, turn the adjusting ring in direction (a). To decrease the spring preload and thereby soften the suspension, turn the adjusting ring in direction (b).

The spring preload setting is determined by measuring distance A. The longer distance A is, the higher the spring preload; the shorter distance A is, the lower the spring preload.

- Use the special wrench in the owner's tool kit to make the adjustment.

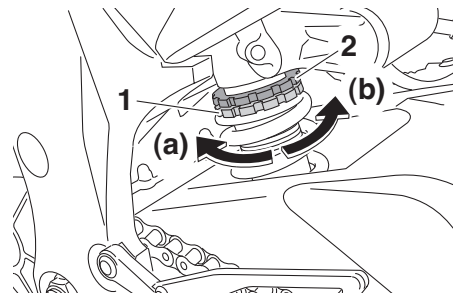

1. Spring preload adjusting ring
2. Locknut

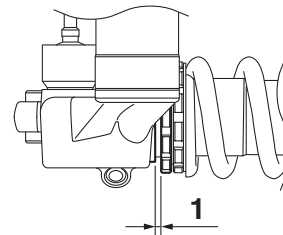

1. Distance A

Spring preload:

Minimum (soft):

Distance A = 0 mm (0.00 in)

Standard:

Distance A = 4 mm (0.16 in)

Maximum (hard):

Distance A = 9 mm (0.35 in)

3. Tighten the locknut to the specified torque. **NOTICE: Always tighten the locknut against the adjusting ring, and then tighten the locknut to the specified torque.**^[ECA22760]

Tightening torque:

Locknut:

25 N·m (2.5 kgf·m, 18 lb·ft)

EAU7050

EXUP system

This model is equipped with Yamaha's EXUP (EXhaust Ultimate Power valve) system. This system boosts engine power by means of a valve that controls exhaust flow within the exhaust chamber.

ECA15611

NOTICE

The EXUP system has been set and extensively tested at the Yamaha factory. Changing these settings without sufficient technical knowledge may result in poor performance of or damage to the engine.

EAU70641

Auxiliary DC connector

This vehicle is equipped with an auxiliary DC connector. Consult your Yamaha dealer before installing any accessories.

Instrument and control functions

Sidestand

EAU15306

The sidestand is located on the left side of the frame. Raise the sidestand or lower it with your foot while holding the vehicle upright.

TIP

The built-in sidestand switch is part of the ignition circuit cut-off system, which cuts the ignition in certain situations. (See the following section for an explanation of the ignition circuit cut-off system.)

WARNING

EWA10242

The vehicle must not be ridden with the sidestand down, or if the sidestand cannot be properly moved up (or does not stay up), otherwise the sidestand could contact the ground and distract the operator, resulting in a possible loss of control. Yamaha's ignition circuit cut-off system has been designed to assist the operator in fulfilling the responsibility of raising the sidestand before starting off. Therefore, check this system regularly and have a

Yamaha dealer repair it if it does not function properly.

EAU57950

Ignition circuit cut-off system

The ignition circuit cut-off system (comprising the sidestand switch, clutch switch and neutral switch) has the following functions.

- It prevents starting when the transmission is in gear and the sidestand is up, but the clutch lever is not pulled.
- It prevents starting when the transmission is in gear and the clutch lever is pulled, but the sidestand is still down.
- It cuts the running engine when the transmission is in gear and the sidestand is moved down.

Periodically check the operation of the ignition circuit cut-off system according to the following procedure.

Instrument and control functions

With the engine turned off:

1. Move the sidestand down.
2. Make sure that the start/engine stop switch is set to “O”.
3. Turn the key on.
4. Shift the transmission into the neutral position.
5. Push the “(⊖)” side of the start/engine stop switch.

Does the engine start?

YES

NO

With the engine still running:

6. Move the sidestand up.
7. Keep the clutch lever pulled.
8. Shift the transmission into gear.
9. Move the sidestand down.

Does the engine stall?

YES

NO

After the engine has stalled:

10. Move the sidestand up.
11. Keep the clutch lever pulled.
12. Push the “(⊖)” side of the start/engine stop switch.

Does the engine start?

YES

NO

The system is OK. **The motorcycle can be ridden.**



WARNING

If a malfunction is noted, have a Yamaha dealer check the system before riding.

The neutral switch may not be working correctly.
The motorcycle should not be ridden until checked by a Yamaha dealer.

The sidestand switch may not be working correctly.
The motorcycle should not be ridden until checked by a Yamaha dealer.

The clutch switch may not be working correctly.
The motorcycle should not be ridden until checked by a Yamaha dealer.

For your safety – pre-operation checks

EAU15599

Inspect your vehicle each time you use it to make sure the vehicle is in safe operating condition. Always follow the inspection and maintenance procedures and schedules described in the Owner's Manual.

EWA11152

WARNING

Failure to inspect or maintain the vehicle properly increases the possibility of an accident or equipment damage. Do not operate the vehicle if you find any problem. If a problem cannot be corrected by the procedures provided in this manual, have the vehicle inspected by a Yamaha dealer.

Before using this vehicle, check the following points:

5

ITEM	CHECKS	PAGE
Fuel	<ul style="list-style-type: none">• Check fuel level in fuel tank.• Refuel if necessary.• Check fuel line for leakage.• Check fuel tank breather hose and overflow hose for obstructions, cracks or damage, and check hose connections.	4-34, 4-36
Engine oil	<ul style="list-style-type: none">• Check oil level in engine.• If necessary, add recommended oil to specified level.• Check vehicle for oil leakage.	7-13
Coolant	<ul style="list-style-type: none">• Check coolant level in reservoir.• If necessary, add recommended coolant to specified level.• Check cooling system for leakage.	7-16
Front brake	<ul style="list-style-type: none">• Check operation.• If soft or spongy, have Yamaha dealer bleed hydraulic system.• Check brake pads for wear.• Replace if necessary.• Check fluid level in reservoir.• If necessary, add specified brake fluid to specified level.• Check hydraulic system for leakage.	7-25

For your safety – pre-operation checks

ITEM	CHECKS	PAGE
Rear brake	<ul style="list-style-type: none"> • Check operation. • If soft or spongy, have Yamaha dealer bleed hydraulic system. • Check brake pads for wear. • Replace if necessary. • Check fluid level in reservoir. • If necessary, add specified brake fluid to specified level. • Check hydraulic system for leakage. 	7-25
Clutch	<ul style="list-style-type: none"> • Check operation. • Lubricate cable if necessary. • Check lever free play. • Adjust if necessary. 	7-23
Throttle grip	<ul style="list-style-type: none"> • Make sure that operation is smooth. • Check throttle grip free play. • If necessary, have Yamaha dealer adjust throttle grip free play and lubricate cable and grip housing. 	7-19, 7-29
Control cables	<ul style="list-style-type: none"> • Make sure that operation is smooth. • Lubricate if necessary. 	7-29
Drive chain	<ul style="list-style-type: none"> • Check chain slack. • Adjust if necessary. • Check chain condition. • Lubricate if necessary. 	7-27, 7-28
Wheels and tires	<ul style="list-style-type: none"> • Check for damage. • Check tire condition and tread depth. • Check air pressure. • Correct if necessary. 	7-20, 7-22
Brake and shift pedals	<ul style="list-style-type: none"> • Make sure that operation is smooth. • Lubricate pedal pivoting points if necessary. 	7-29
Brake and clutch levers	<ul style="list-style-type: none"> • Make sure that operation is smooth. • Lubricate lever pivoting points if necessary. 	7-30
Sidestand	<ul style="list-style-type: none"> • Make sure that operation is smooth. • Lubricate pivot if necessary. 	7-31
Chassis fasteners	<ul style="list-style-type: none"> • Make sure that all nuts, bolts and screws are properly tightened. • Tighten if necessary. 	—

For your safety – pre-operation checks

ITEM	CHECKS	PAGE
Air intake duct	<ul style="list-style-type: none">• Make sure that the air intake duct is not blocked.• Remove any foreign objects from the screen if necessary.	—
Instruments, lights, signals and switches	<ul style="list-style-type: none">• Check operation.• Correct if necessary.	—
Sidestand switch	<ul style="list-style-type: none">• Check operation of ignition circuit cut-off system.• If system is not working correctly, have Yamaha dealer check vehicle.	4-47

Read the Owner's Manual carefully to become familiar with all controls. If there is a control or function you do not understand, ask your Yamaha dealer.

EWA10272

WARNING

Failure to familiarize yourself with the controls can lead to loss of control, which could cause an accident or injury.

TIP

This model is equipped with:

- an inertial measurement unit (IMU) that will stop the engine in case of turnover. In this case, turn the key to "OFF" and then to "ON" before attempting to restart the engine. Failing to do so will prevent the engine from starting even though the engine will crank when the start switch is pushed.
- an engine auto-stop system. The engine stops automatically if left idling for 20 minutes. In this case, simply push the start switch to restart the engine.

Starting the engine

In order for the ignition circuit cut-off system (page 4-47) to enable starting, one of the following conditions must be met:

- The transmission is in the neutral position.
- The transmission is in gear with the clutch lever pulled and the sidestand up.

To start the engine

1. Turn the key to "ON" and make sure that the engine stop switch is set to "○".
2. Confirm that the following warning and indicator lights come on.
 - Engine trouble warning light
 - Oil pressure and coolant temperature warning light*
 - ABS warning light*
 - Fuel level warning light*
 - Steering damper and suspension warning light
 - Shift timing indicator light
 - Stability control indicator light
 - Immobilizer system indicator

Operation and important riding points

light

TIP

- The ABS warning light should come on and stay on until the vehicle reaches a traveling speed of 10 km/h (6 mi/h).
- The oil pressure and coolant temperature warning light should come on, go off briefly, and then remain on until the engine is started.
- The fuel level warning light will stay on if you are low on fuel.

ECA24110

NOTICE

If a warning or indicator light does not work as described above, have a Yamaha dealer check the vehicle.

3. Shift the transmission into the neutral position (or hold the clutch lever pulled with the sidestand up).
4. Push the start switch, and release it when the engine starts.

If the engine does not start within 5 seconds of pressing the start switch, wait 10 seconds before pressing the switch again to allow

the battery voltage to restore.

ECA11043

NOTICE

For maximum engine life, never accelerate hard when the engine is cold!

Shifting

EAU67080

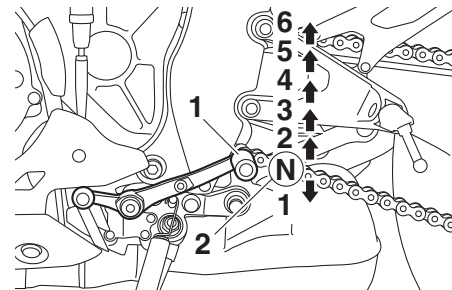

1. Shift pedal
2. Neutral position

Shifting gears lets you control the amount of engine power available for starting off, accelerating, climbing hills, etc.

The gear positions are shown in the illustration.

TIP

For speedy upshifts, turn on the quick shift system. See QSS on page 4-17 for more information.

ECA22520

NOTICE

- Even with the transmission in

the neutral position, do not coast for long periods of time with the engine off, and do not tow the motorcycle for long distances. The transmission is properly lubricated only when the engine is running. Inadequate lubrication may damage the transmission.

- Except when upshifting with the QSS turned on, always use the clutch while changing gears to avoid damaging the engine, transmission, and drive train, which are not designed to withstand the shock of forced shifting.

EAU16811

Tips for reducing fuel consumption

Fuel consumption depends largely on your riding style. Consider the following tips to reduce fuel consumption:

- Shift up swiftly, and avoid high engine speeds during acceleration.
- Do not rev the engine while shifting down, and avoid high engine speeds with no load on the engine.
- Turn the engine off instead of letting it idle for an extended length of time (e.g., in traffic jams, at traffic lights or at railroad crossings).

EAU16842

Engine break-in

There is never a more important period in the life of your engine than the period between 0 and 1600 km (1000 mi). For this reason, you should read the following material carefully.

Since the engine is brand new, do not put an excessive load on it for the first 1600 km (1000 mi). The various parts in the engine wear and polish themselves to the correct operating clearances. During this period, prolonged full-throttle operation or any condition that might result in engine overheating must be avoided.

EAU17085

0–1000 km (0–600 mi)

Avoid prolonged operation above 7000 r/min. **NOTICE: After 1000 km (600 mi) of operation, the engine oil must be changed and the oil filter cartridge or element replaced.**^[ECA10303]

1000–1600 km (600–1000 mi)

Avoid prolonged operation above 8400

Operation and important riding points

r/min.

1600 km (1000 mi) and beyond

The vehicle can now be operated normally.

ECA10311

NOTICE

- Keep the engine speed out of the tachometer red zone.
- If any engine trouble should occur during the engine break-in period, immediately have a Yamaha dealer check the vehicle.

TIP

During and after the engine break-in period, the exhaust heat may cause discoloration of the exhaust pipe, but this is normal.

EAU17214

Parking

When parking, stop the engine, and then remove the key from the main switch.

EWA10312

WARNING

- Since the engine and exhaust system can become very hot, park in a place where pedestrians or children are not likely to touch them and be burned.
- Do not park on a slope or on soft ground, otherwise the vehicle may overturn, increasing the risk of a fuel leak and fire.
- Do not park near grass or other flammable materials which might catch fire.

EAU17246

EWA15123

EAU17303

Periodic inspection, adjustment, and lubrication will keep your vehicle in the safest and most efficient condition possible. Safety is an obligation of the vehicle owner/operator. The most important points of vehicle inspection, adjustment, and lubrication are explained on the following pages.

The intervals given in the periodic maintenance charts should be simply considered as a general guide under normal riding conditions. However, depending on the weather, terrain, geographical location, and individual use, the maintenance intervals may need to be shortened.

WARNING

EWA10322

Failure to properly maintain the vehicle or performing maintenance activities incorrectly may increase your risk of injury or death during service or while using the vehicle. If you are not familiar with vehicle service, have a Yamaha dealer perform service.

WARNING

Turn off the engine when performing maintenance unless otherwise specified.

- **A running engine has moving parts that can catch on body parts or clothing and electrical parts that can cause shocks or fires.**
- **Running the engine while servicing can lead to eye injury, burns, fire, or carbon monoxide poisoning – possibly leading to death. See page 1-2 for more information about carbon monoxide.**

EWA15461

WARNING

Brake discs, calipers, drums, and linings can become very hot during use. To avoid possible burns, let brake components cool before touching them.

Emission controls not only function to ensure cleaner air, but are also vital to proper engine operation and maximum performance. In the following periodic maintenance charts, the services related to emissions control are grouped separately. These services require specialized data, knowledge, and equipment. Maintenance, replacement, or repair of the emission control devices and systems may be performed by any repair establishment or individual that is certified (if applicable). Yamaha dealers are trained and equipped to perform these particular services.

Periodic maintenance and adjustment

EAU67090

Owner's tool kit

The owner's tool kit should be stored separately from the vehicle. However, there are two hexagon wrenches stored under the passenger seat. (See page 4-37.)

ence required for a particular job, have a Yamaha dealer perform it for you.

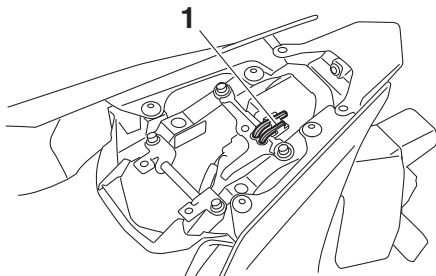

1. Hexagon wrench

The service information included in this manual and the tools provided are intended to assist you in the performance of preventive maintenance and minor repairs. However, additional tools, such as a torque wrench, are necessary to perform certain maintenance work correctly.

TIP _____
If you do not have the tools or experi-

Periodic maintenance and adjustment

EAU71030

TIP

- The annual checks must be performed every year, except if a kilometer-based maintenance, or for the UK, a mileage-based maintenance, is performed instead.
- From 50000 km (30000 mi), repeat the maintenance intervals starting from 10000 km (6000 mi).
- Items marked with an asterisk should be performed by a Yamaha dealer as they require special tools, data and technical skills.

EAU71051

Periodic maintenance chart for the emission control system

NO.	ITEM	CHECK OR MAINTENANCE JOB	ODOMETER READING					ANNUAL CHECK
			1000 km (600 mi)	10000 km (6000 mi)	20000 km (12000 mi)	30000 km (18000 mi)	40000 km (24000 mi)	
1	* Fuel line	<ul style="list-style-type: none"> • Check fuel hoses for cracks or damage. • Replace if necessary. 		√	√	√	√	√
2	* Spark plugs	<ul style="list-style-type: none"> • Check condition. • Adjust gap and clean. 		√		√		
		<ul style="list-style-type: none"> • Replace. 			√		√	
3	* Valve clearance	<ul style="list-style-type: none"> • Check and adjust. 	Every 40000 km (24000 mi)					
4	* Fuel injection	<ul style="list-style-type: none"> • Check engine idle speed. 	√	√	√	√	√	√
		<ul style="list-style-type: none"> • Check and adjust synchronization. 		√	√	√	√	√
5	* Exhaust system	<ul style="list-style-type: none"> • Check for leakage. • Tighten if necessary. • Replace gaskets if necessary. 	√	√	√	√	√	
6	* Evaporative emission control system	<ul style="list-style-type: none"> • Check control system for damage. • Replace if necessary. 			√		√	

Periodic maintenance and adjustment

NO.	ITEM	CHECK OR MAINTENANCE JOB	ODOMETER READING					ANNUAL CHECK
			1000 km (600 mi)	10000 km (6000 mi)	20000 km (12000 mi)	30000 km (18000 mi)	40000 km (24000 mi)	
7	* Air induction system	<ul style="list-style-type: none"> • Check the air cut-off valve, reed valve, and hose for damage. • Replace any damaged parts if necessary. 		√	√	√	√	√

Periodic maintenance and adjustment

EAU71351

General maintenance and lubrication chart

NO.	ITEM	CHECK OR MAINTENANCE JOB	ODOMETER READING					ANNUAL CHECK
			1000 km (600 mi)	10000 km (6000 mi)	20000 km (12000 mi)	30000 km (18000 mi)	40000 km (24000 mi)	
1	* Diagnostic system check	<ul style="list-style-type: none"> Perform dynamic inspection using Yamaha diagnostic tool. Check the error codes. 	√	√	√	√	√	√
2	* Air filter element	<ul style="list-style-type: none"> Replace. 	Every 40000 km (24000 mi)					
3	Clutch	<ul style="list-style-type: none"> Check operation. Adjust. 	√	√	√	√	√	
4	* Front brake	<ul style="list-style-type: none"> Check operation, fluid level, and for fluid leakage. Replace brake pads if necessary. 	√	√	√	√	√	√
5	* Rear brake	<ul style="list-style-type: none"> Check operation, fluid level, and for fluid leakage. Replace brake pads if necessary. 	√	√	√	√	√	√
6	* Brake hoses	<ul style="list-style-type: none"> Check for cracks or damage. 		√	√	√	√	√
		<ul style="list-style-type: none"> Replace. 	Every 4 years					
7	* Brake fluid	<ul style="list-style-type: none"> Change. 	Every 2 years					
8	* Wheels	<ul style="list-style-type: none"> Check runout and for damage. Replace if necessary. 		√	√	√	√	
9	* Tires	<ul style="list-style-type: none"> Check tread depth and for damage. Replace if necessary. Check air pressure. Correct if necessary. 		√	√	√	√	√
10	* Wheel bearings	<ul style="list-style-type: none"> Check bearing for looseness or damage. 		√	√	√	√	
11	* Swingarm pivot bearings	<ul style="list-style-type: none"> Check operation and for excessive play. 		√	√	√	√	
		<ul style="list-style-type: none"> Lubricate with lithium-soap-based grease. 	Every 50000 km (30000 mi)					

Periodic maintenance and adjustment

NO.	ITEM	CHECK OR MAINTENANCE JOB	ODOMETER READING					ANNUAL CHECK
			1000 km (600 mi)	10000 km (6000 mi)	20000 km (12000 mi)	30000 km (18000 mi)	40000 km (24000 mi)	
12	Drive chain	<ul style="list-style-type: none"> • Check chain slack, alignment and condition. • Adjust and lubricate chain with a special O-ring chain lubricant thoroughly. 	Every 800 km (500 mi) and after washing the motorcycle, riding in the rain or riding in wet areas					
13	* Steering bearings	<ul style="list-style-type: none"> • Check bearing assemblies for looseness. 	√	√		√		
		<ul style="list-style-type: none"> • Moderately repack with lithium-soap-based grease. 			√		√	
14	* Steering damper	<ul style="list-style-type: none"> • Check operation and for oil leakage. 		√	√	√	√	
15	* Chassis fasteners	<ul style="list-style-type: none"> • Make sure that all nuts, bolts and screws are properly tightened. 		√	√	√	√	√
16	Brake lever pivot shaft	<ul style="list-style-type: none"> • Lubricate with silicone grease. 		√	√	√	√	√
17	Brake pedal pivot shaft	<ul style="list-style-type: none"> • Lubricate with lithium-soap-based grease. 		√	√	√	√	√
18	Clutch lever pivot shaft	<ul style="list-style-type: none"> • Lubricate with lithium-soap-based grease. 		√	√	√	√	√
19	Shift pedal pivot shaft	<ul style="list-style-type: none"> • Lubricate with lithium-soap-based grease. 		√	√	√	√	√
20	Sidestand	<ul style="list-style-type: none"> • Check operation. • Lubricate with lithium-soap-based grease. 		√	√	√	√	√
21	* Sidestand switch	<ul style="list-style-type: none"> • Check operation and replace if necessary. 	√	√	√	√	√	√
22	* Front fork	<ul style="list-style-type: none"> • Check operation and for oil leakage. • Replace if necessary. 		√	√	√	√	
23	* Shock absorber assembly	<ul style="list-style-type: none"> • Check operation and for oil leakage. • Replace if necessary. 		√	√	√	√	

Periodic maintenance and adjustment

NO.	ITEM	CHECK OR MAINTENANCE JOB	ODOMETER READING					ANNUAL CHECK
			1000 km (600 mi)	10000 km (6000 mi)	20000 km (12000 mi)	30000 km (18000 mi)	40000 km (24000 mi)	
24	* Rear suspension relay arm and connecting arm pivoting points	<ul style="list-style-type: none"> • Check operation. 		√	√	√	√	
25	Engine oil	<ul style="list-style-type: none"> • Change (warm engine before draining). • Check oil level and vehicle for oil leakage. 	√	√	√	√	√	√
26	Engine oil filter cartridge	<ul style="list-style-type: none"> • Replace. 	√		√		√	
27	* Cooling system	<ul style="list-style-type: none"> • Check coolant level and vehicle for coolant leakage. • Change. 		√	√	√	√	√
28	* EXUP system	<ul style="list-style-type: none"> • Check operation, cable free play and pulley position. 	√		√		√	
29	* Front and rear brake switches	<ul style="list-style-type: none"> • Check operation. 	√	√	√	√	√	√
30	* Moving parts and cables	<ul style="list-style-type: none"> • Lubricate. 		√	√	√	√	√
31	* Throttle grip housing and cable	<ul style="list-style-type: none"> • Check operation and free play. • Adjust the throttle cable free play if necessary. • Lubricate the throttle grip housing and cable. 		√	√	√	√	√
32	* Lights, signals and switches	<ul style="list-style-type: none"> • Check operation. • Adjust headlight beam. 	√	√	√	√	√	√

Periodic maintenance and adjustment

EAU72811

TIP

- Air filter
 - This model's air filter uses a disposable oil-coated paper element. This element cannot be cleaned with compressed air, doing so will only damage it.
 - The air filter element needs to be replaced more frequently when riding in unusually wet or dusty areas.
 - Hydraulic brake service
 - Regularly check the front and rear brake fluid levels. Replenish if necessary.
 - Every two years replace the rear brake master cylinder, the internal components of the front brake master cylinder, the brake calipers, and change the brake fluid.
 - Replace the brake hoses every four years or sooner if cracked, damaged, or if any section of the stainless steel brake hose has turned black.
-

Periodic maintenance and adjustment

Removing and installing cowlings and panels

EAU18713

The cowlings and panels shown need to be removed to perform some of the maintenance jobs described in this chapter. Refer to this section each time a cowling or panel needs to be removed and installed.

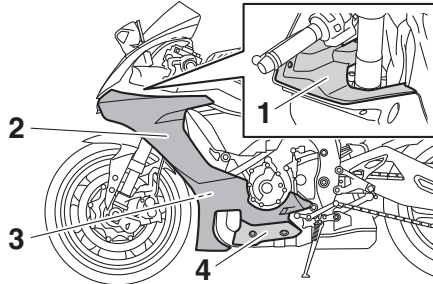

1. Panel A
2. Cowling A
3. Cowling C
4. Panel B

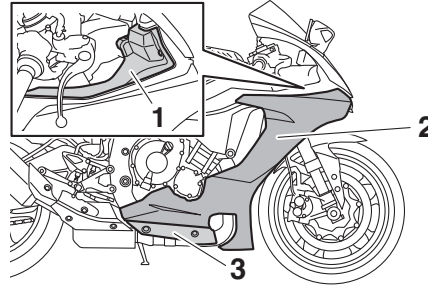

1. Panel C
2. Cowling B
3. Panel D

Cowlings A and B (for YZF-R1)

To remove a cowling

Remove the quick fastener screws and the quick fasteners, and then take the cowling off.

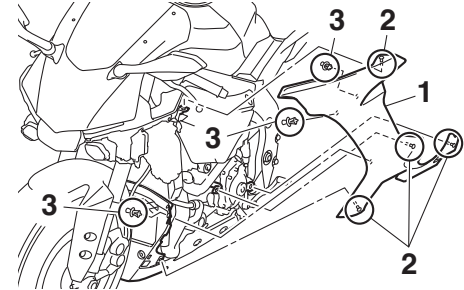

1. Cowling A
2. Quick fastener screw
3. Quick fastener

EAU66972

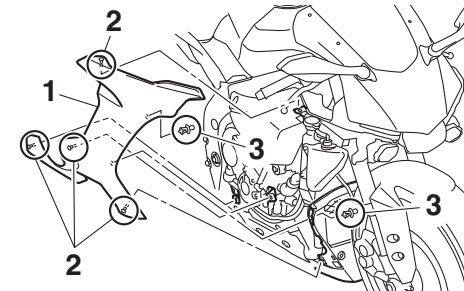

1. Cowling B
2. Quick fastener screw
3. Quick fastener

To install a cowling

Place the cowling in its original position,

Periodic maintenance and adjustment

and then install the quick fasteners and the quick fastener screws.

Cowling C (for YZF-R1)

To remove a cowling

1. Remove cowlings A and B.
2. Remove the screws and collars, and then take the cowling off.

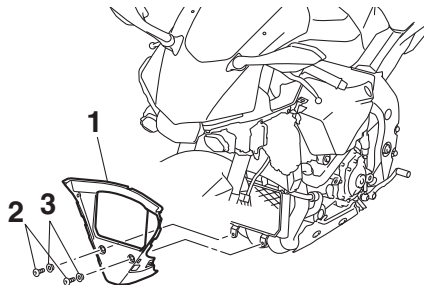

1. Cowling C
2. Screw
3. Collar

To install a cowling

1. Place the cowling in its original position and then install the collars and screws.
2. Install cowlings A and B.

Cowlings A and B (for YZF-R1M)

To remove a cowling

Remove the screw, collar, quick fastener screws and the quick fasteners, and then take the cowling off.

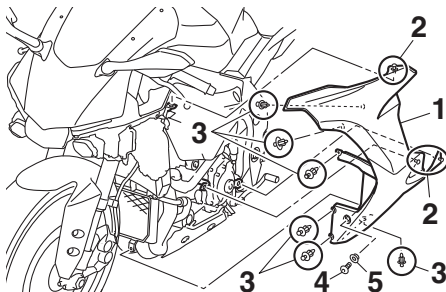

1. Cowling A
2. Quick fastener screw
3. Quick fastener
4. Screw
5. Collar

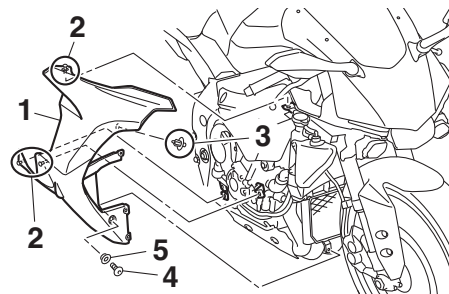

1. Cowling B
2. Quick fastener screw
3. Quick fastener
4. Screw
5. Collar

To install a cowling

Place the cowling in its original position, and then install the collar, screw, quick fasteners and the quick fastener screws.

Panels A and C

To remove a panel

Remove the quick fastener and screw,

Periodic maintenance and adjustment

and then pull the panel off.

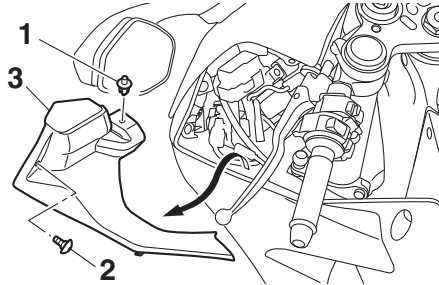

1. Quick fastener
2. Screw
3. Panel A

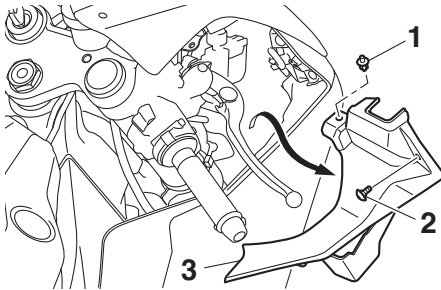

1. Quick fastener
2. Screw
3. Panel C

To install the panel

Place the panel in the original position, and then install the quick fastener and screw.

Panels B and D

To remove a panel

1. Remove cowling A or B. (See page 7-9.)
2. Remove the screws, and then pull the panel off.

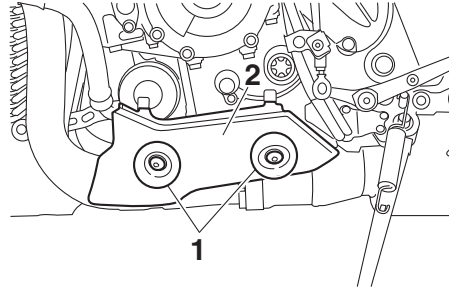

1. Screw
2. Panel B

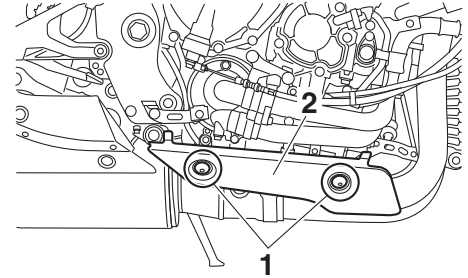

1. Screw
2. Panel D

To install the panel

Place the panel in the original position, and then install the screws.

Periodic maintenance and adjustment

EAU67110

Checking the spark plugs

The spark plugs are important engine components, which should be checked periodically, preferably by a Yamaha dealer. Since heat and deposits will cause any spark plug to slowly erode, they should be removed and checked in accordance with the periodic maintenance and lubrication chart. In addition, the condition of the spark plugs can reveal the condition of the engine.

The porcelain insulator around the center electrode of each spark plug should be a medium-to-light tan (the ideal color when the vehicle is ridden normally), and all spark plugs installed in the engine should have the same color. If any spark plug shows a distinctly different color, the engine could be operating improperly. Do not attempt to diagnose such problems yourself. Instead, have a Yamaha dealer check the vehicle.

If a spark plug shows signs of electrode erosion and excessive carbon or other deposits, it should be replaced.

Specified spark plug:
NGK/LMAR9E-J

Before installing a spark plug, the spark plug gap should be measured with a wire thickness gauge and, if necessary, adjusted to specification.

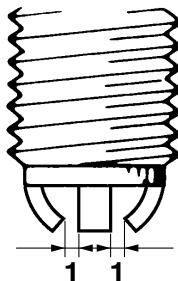

1. Spark plug gap

Spark plug gap:
0.6–0.7 mm (0.024–0.028 in)

Clean the surface of the spark plug gasket and its mating surface, and then wipe off any grime from the spark plug threads.

Tightening torque:
Spark plug (new):
18 N·m (1.8 kgf·m, 13 lb·ft)
Spark plug (after checking):
13 N·m (1.3 kgf·m, 9.4 lb·ft)

ECA10841

NOTICE

Do not use any tools to remove or install the spark plug cap, otherwise the ignition coil coupler may get damaged. The spark plug cap may be difficult to remove because the rubber seal on the end of the cap fits tightly. To remove the spark plug cap, simply twist it back and forth while pulling it out; to install it, twist it back and forth while pushing it in.

Canister

EAU36112

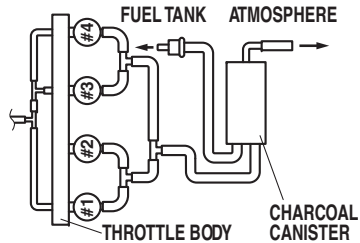

This model is equipped with a canister to prevent the discharging of fuel vapor into the atmosphere. Before operating this vehicle, make sure to check the following:

- Check each hose connection.
- Check each hose and canister for cracks or damage. Replace if damaged.
- Make sure that the canister breather is not blocked, and if necessary, clean it.

Engine oil and oil filter cartridge

EAU66533

The engine oil level should be checked before each ride. In addition, the oil must be changed and the oil filter cartridge replaced at the intervals specified in the periodic maintenance and lubrication chart.

To check the engine oil level

1. Place the vehicle on a level surface and hold it in an upright position. A slight tilt to the side can result in a false reading.
2. Start the engine, warm it up for several minutes, and then turn it off.
3. Wait a few minutes until the oil settles, and then check the oil level through the check window located at the bottom-left side of the crankcase.

TIP

The engine oil should be between the minimum and maximum level marks.

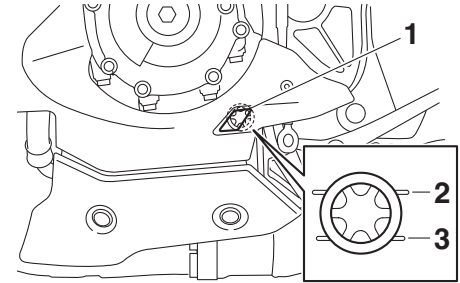

1. Engine oil level check window
2. Maximum level mark
3. Minimum level mark
4. If the engine oil is at or below the minimum level mark, add sufficient oil of the recommended type to raise it to the correct level.

To change the engine oil (with or without oil filter cartridge replacement)

1. Remove cowling A and panel B. (See page 7-9.)
2. Start the engine, warm it up for several minutes, and then turn it off.
3. Place an oil pan under the engine to collect the used oil.

Periodic maintenance and adjustment

4. Remove the engine oil filler cap, the engine oil drain bolt and its gasket to drain the oil from the crankcase.

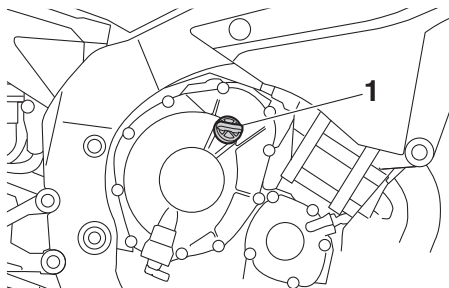

1. Engine oil filler cap

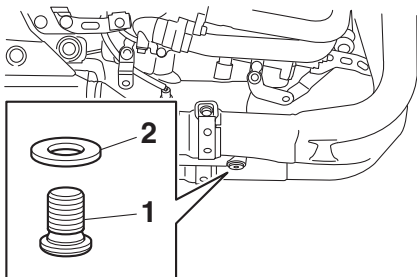

1. Engine oil drain bolt
2. Gasket

TIP _____
Skip steps 5–7 if the oil filter cartridge is not being replaced.

5. Remove the oil filter cartridge with an oil filter wrench.

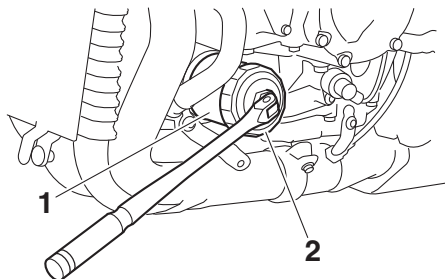

1. Oil filter cartridge
2. Oil filter wrench

TIP _____
An oil filter wrench is available at a Yamaha dealer.

6. Apply a thin coat of clean engine oil to the O-ring of the new oil filter cartridge.

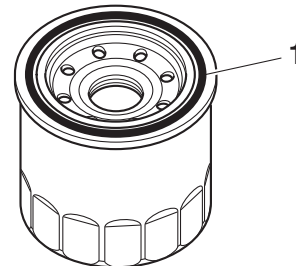

1. O-ring

TIP _____
Make sure that the O-ring is properly seated.

7. Install the new oil filter cartridge with an oil filter wrench, and then tighten it to the specified torque with a torque wrench.

Periodic maintenance and adjustment

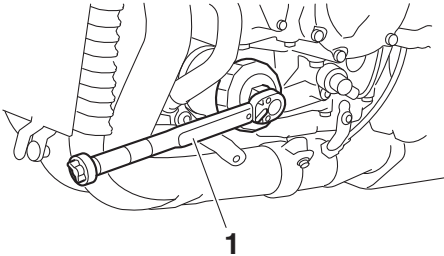

1. Torque wrench

Tightening torque:

Oil filter cartridge:
17 N·m (1.7 kgf·m, 12 lb·ft)

8. Install the engine oil drain bolt and its new gasket, and then tighten the bolt to the specified torque.

Tightening torque:

Engine oil drain bolt:
23 N·m (2.3 kgf·m, 17 lb·ft)

9. Refill with the specified amount of the recommended engine oil, and then install and tighten the oil filler cap.

Recommended engine oil:

Full synthetic
10W-40, 15W-50

Oil quantity:

Oil change:
3.90 L (4.12 US qt, 3.43 Imp.qt)
With oil filter removal:
4.10 L (4.33 US qt, 3.61 Imp.qt)

TIP

Be sure to wipe off spilled oil on any parts after the engine and exhaust system have cooled down.

ECA11621

NOTICE

- In order to prevent clutch slippage (since the engine oil also lubricates the clutch), do not mix any chemical additives. Do not use oils with a diesel specification of “CD” or oils of a higher quality than specified. In addition, do not use oils labeled “ENERGY CONSERVING II” or higher.
- Make sure that no foreign material enters the crankcase.

10. Start the engine, and then let it idle for several minutes while checking

it for oil leakage. If oil is leaking, immediately turn the engine off and check for the cause.

TIP

After the engine is started, the oil pressure and coolant temperature warning light should go off if the oil level is sufficient.

ECA22490

NOTICE

If the oil pressure and coolant temperature warning light flickers or remains on even if the oil level is correct, immediately turn the engine off and have a Yamaha dealer check the vehicle.

11. Turn the engine off, wait a few minutes until the oil settles, and then check the oil level and correct it if necessary.
12. Install the cowling and panel.

Periodic maintenance and adjustment

Coolant

The coolant level should be checked before each ride. In addition, the coolant must be changed at the intervals specified in the periodic maintenance and lubrication chart.

EAU20071

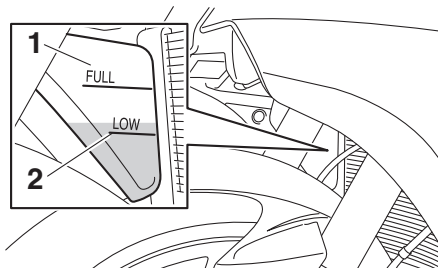

To check the coolant level

1. Place the vehicle on a level surface and hold it in an upright position.

EAU66510

TIP

- The coolant level must be checked on a cold engine since the level varies with engine temperature.
- Make sure that the vehicle is positioned straight up when checking the coolant level. A slight tilt to the side can result in a false reading.

2. Check the coolant level in the coolant reservoir.

TIP

The coolant should be between the minimum and maximum level marks.

1. Maximum level mark
2. Minimum level mark
3. If the coolant is at or below the minimum level mark, remove cowlings B. (See page 7-9.)
4. Remove the coolant reservoir cap, add coolant to the maximum level mark, and then install the reservoir cap. **WARNING! Remove only the coolant reservoir cap. Never attempt to remove the radiator cap when the engine is hot.**^[EWA15162] **NOTICE: If coolant is not available, use distilled water or soft tap water instead. Do not use hard water or salt water since it is harmful to the engine. If water has been used instead**

of coolant, replace it with coolant as soon as possible, otherwise the cooling system will not be protected against frost and corrosion. If water has been added to the coolant, have a Yamaha dealer check the anti-freeze content of the coolant as soon as possible, otherwise the effectiveness of the coolant will be reduced.^[ECA10473]

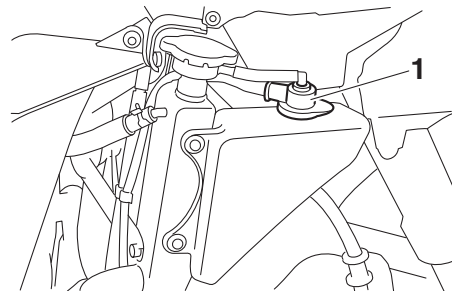

1. Coolant reservoir cap

Coolant reservoir capacity (up to the maximum level mark):
0.25 L (0.26 US qt, 0.22 Imp.qt)

5. Install the cowlings.

Periodic maintenance and adjustment

EAU66520

To change the coolant

1. Place the vehicle on a level surface and let the engine cool if necessary.
2. Remove cowling B and panel D. (See page 7-9.)
3. Place a container under the engine to collect the used coolant.
4. Remove the radiator cap.
WARNING! Never attempt to remove the radiator cap when the engine is hot.^[EWA10382]

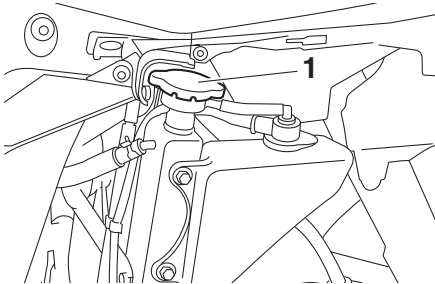

1. Radiator cap

5. Remove the coolant drain bolt and its gasket to drain the cooling system.

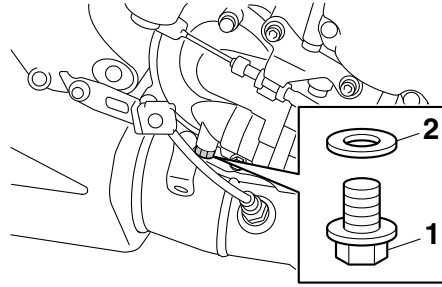

1. Coolant drain bolt
2. Gasket

6. Remove the coolant reservoir cap.

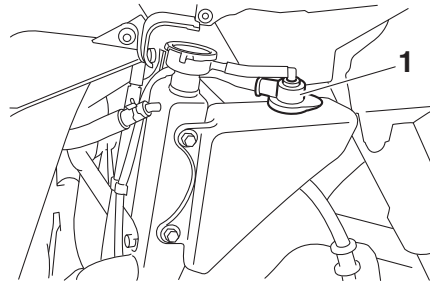

1. Coolant reservoir cap

7. Remove the coolant reservoir by removing the bolts, and then turn the reservoir upside down to empty it.

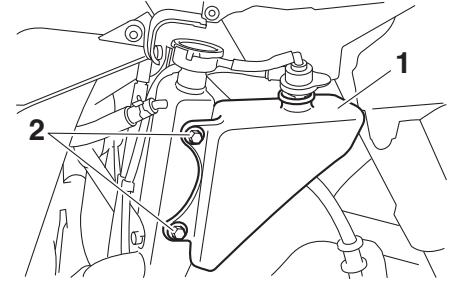

1. Coolant reservoir
2. Bolt

8. After the coolant is completely drained, thoroughly flush the cooling system with clean tap water.
9. Install the coolant reservoir by installing the bolts.
10. Install the coolant drain bolt and its new gasket, and then tighten the bolt to the specified torque.

Tightening torque:

Coolant drain bolt:
10 N·m (1.0 kgf·m, 7.2 lb·ft)

11. Pour the specified amount of the recommended coolant into the radiator and reservoir.

Periodic maintenance and adjustment

EAU36765

Antifreeze/water mixture ratio:

1:1

Recommended antifreeze:

High-quality ethylene glycol antifreeze containing corrosion inhibitors for aluminum engines

Coolant quantity:

Radiator (including all routes):

2.25 L (2.38 US qt, 1.98 Imp.qt)

Coolant reservoir (up to the maximum level mark):

0.25 L (0.26 US qt, 0.22 Imp.qt)

12. Install the coolant reservoir cap.
13. Loosen the air bleed bolt to allow any trapped air to escape from the water pump.

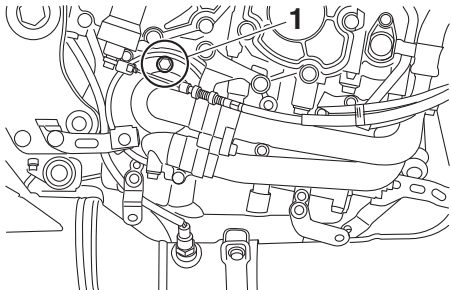

1. Air bleed bolt

14. When coolant begins to flow out, tighten the air bleed bolt to the

specified torque.

Tightening torque:

Air bleed bolt:

10 N·m (1.0 kgf·m, 7.2 lb·ft)

15. Pour the specified coolant into the radiator until it is full.
16. Install the radiator cap.
17. Start the engine, let it idle for several minutes, and then turn it off.
18. Remove the radiator cap to check the coolant level in the radiator. If necessary, add sufficient coolant until it reaches the top of the radiator, and then install the radiator cap.
19. Start the engine, and then check the vehicle for coolant leakage. If coolant is leaking, have a Yamaha dealer check the cooling system.
20. Install the cowling and panel.

Air filter element

The air filter element must be replaced at the intervals specified in the periodic maintenance and lubrication chart. Have a Yamaha dealer replace the air filter element.

EAU44735

Checking the engine idling speed

Check the engine idling speed and, if necessary, have it corrected by a Yamaha dealer.

Engine idling speed:
1200–1400 r/min

EAU21386

Checking the throttle grip free play

Measure the throttle grip free play as shown.

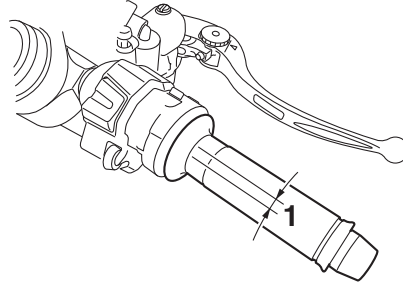

1. Throttle grip free play

Throttle grip free play:
3.0–5.0 mm (0.12–0.20 in)

Periodically check the throttle grip free play and, if necessary, have a Yamaha dealer adjust it.

EAU21402

Valve clearance

The valve clearance changes with use, resulting in improper air-fuel mixture and/or engine noise. To prevent this from occurring, the valve clearance must be adjusted by a Yamaha dealer at the intervals specified in the periodic maintenance and lubrication chart.

Periodic maintenance and adjustment

Tires

EAU70961

Tires are the only contact between the vehicle and the road. Safety in all conditions of riding depends on a relatively small area of road contact. Therefore, it is essential to maintain the tires in good condition at all times and replace them at the appropriate time with the specified tires.

Tire air pressure

The tire air pressure should be checked and, if necessary, adjusted before each ride.

EWA18370

⚠ WARNING

- Operation of this vehicle with improper tire air pressure may cause severe injury or death from loss of control.
- The tire air pressure must be checked and adjusted on cold tires (i.e., when the temperature of the tires equals the ambient temperature).

Cold tire air pressure:

Front:
250 kPa (2.50 kgf/cm², 36 psi)

Rear:
290 kPa (2.90 kgf/cm², 42 psi)

Maximum load*:

187 kg (412 lb)

* Total weight of rider, passenger, cargo and accessories

EWA10512

⚠ WARNING

Never overload your vehicle. Operation of an overloaded vehicle could cause an accident.

Tire inspection

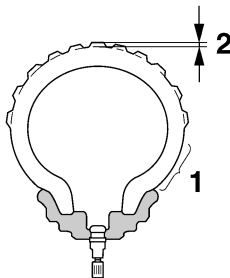

1. Tire sidewall
2. Tire tread depth

The tires should be checked before each ride. If the center tread depth reaches the specified limit, if the tire has a nail or glass fragments in it, or if the sidewall is cracked, have a Yamaha dealer replace the tire immediately.

Minimum tire tread depth (front and rear):

1.6 mm (0.06 in)

EWA10472

⚠ WARNING

- Have a Yamaha dealer replace excessively worn tires. Besides being illegal, operating the vehicle with excessively worn tires decreases riding stability and can lead to loss of control.
- The replacement of all wheel and brake-related parts, including the tires, should be left to a Yamaha dealer, who has the necessary professional knowledge and experience to do so.

Periodic maintenance and adjustment

- **Ride at moderate speeds after changing a tire since the tire surface must first be “broken in” for it to develop its optimal characteristics.**

Tire information

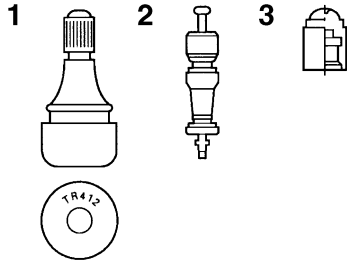

1. Tire air valve
2. Tire air valve core
3. Tire air valve cap with seal

This model is equipped with tubeless tires and tire air valves.

Tires age, even if they have not been used or have only been used occasionally. Cracking of the tread and sidewall rubber, sometimes accompanied by carcass deformation, is an evidence of ageing. Old and aged tires should be

checked by tire specialists to ascertain their suitability for further use.

EWA10482

! WARNING

- **The front and rear tires should be of the same make and design, otherwise the handling characteristics of the motorcycle may be different, which could lead to an accident.**
- **Always make sure that the valve caps are securely installed to prevent air pressure leakage.**
- **Use only the tire valves and valve cores listed below to avoid tire deflation during a high-speed ride.**

After extensive tests, only the tires listed below are approved for this model by Yamaha.

Front tire:

Size:

120/70 ZR17MC (58W)

Manufacturer/model:

BRIDGESTONE/BATTLAX RACING STREET RS10F

Rear tire:

Size:

190/55 ZR17M/C (75W) (YZF-R1)

200/55 ZR17M/C (78W)

(YZF-R1M)

Manufacturer/model:

BRIDGESTONE/BATTLAX RACING STREET RS10R

FRONT and REAR:

Tire air valve:

TR412

Valve core:

#9100 (original)

EWA10601

! WARNING

This motorcycle is fitted with super-high-speed tires. Note the following points in order to make the most efficient use of these tires.

- **Use only the specified replacement tires. Other tires may run the danger of bursting at super high speeds.**
- **Brand-new tires can have a relatively poor grip on certain road**

Periodic maintenance and adjustment

surfaces until they have been “broken in”. Therefore, it is advisable before doing any high-speed riding to ride conservatively for approximately 100 km (60 mi) after installing a new tire.

- The tires must be warmed up before a high-speed run.
 - Always adjust the tire air pressure according to the operating conditions.
-

EAU66460

Cast magnesium wheels

To maximize the performance, durability, and safe operation of your motorcycle, note the following points regarding these wheels.

- The wheel rims should be checked for cracks, bends, warpage or damage before each ride. If any damage is found, have a Yamaha dealer replace the wheel. Do not attempt even the smallest repair to the wheel. A deformed or cracked wheel must be replaced.
- The wheel should be balanced whenever the tire or wheel has been changed or replaced. An unbalanced wheel can result in poor performance, adverse handling characteristics, and shortened tire life.

These wheels are made of magnesium and require special care.

- When balancing the wheel, use press-on type weights to avoid scratching the wheel.
- Regularly inspect the wheel for nicks and scratches. Use touch-up paint or other sealant to prevent

corrosion.

- Follow the instructions for cleaning provided on page 8-1.

Periodic maintenance and adjustment

EAU67342

Adjusting the clutch lever free play

Measure the clutch lever free play as shown.

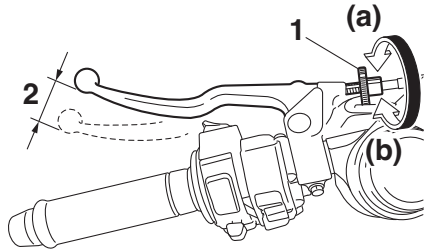

1. Clutch lever free play adjusting bolt
2. Clutch lever free play

Clutch lever free play:
10.0–15.0 mm (0.39–0.59 in)

Periodically check the clutch lever free play and, if necessary, adjust it as follows.

To increase the clutch lever free play, turn the clutch lever free play adjusting bolt at the clutch lever in direction (a). To decrease the clutch lever free play, turn the adjusting bolt in direction (b).

TIP

If the specified clutch lever free play cannot be obtained as described above, proceed as follows.

1. Fully turn the adjusting bolt at the clutch lever in direction (a) to loosen the clutch cable.
2. Remove cowling B. (See page 7-9.)
3. Loosen the locknut further down the clutch cable.
4. To increase the clutch lever free play, turn the clutch lever free play adjusting nut in direction (a). To decrease the clutch lever free play, turn the adjusting nut in direction (b).

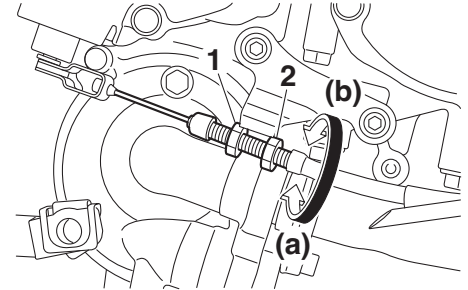

1. Locknut
2. Clutch lever free play adjusting nut
5. Tighten the locknut.
6. Install the cowling.

Periodic maintenance and adjustment

Checking the brake lever free play

EAU37914

sult in loss of control and an accident.

EAU36504

Brake light switches

The brake light, which is activated by the brake pedal and brake lever, should come on just before braking takes effect. If necessary, have a Yamaha dealer adjust the brake light switches.

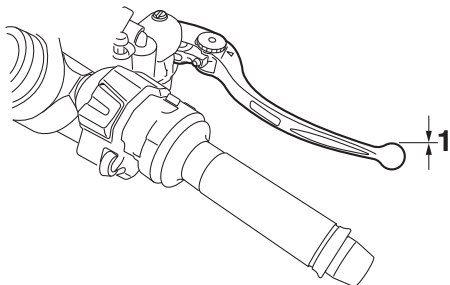

1. No brake lever free play

7

There should be no free play at the brake lever end. If there is free play, have a Yamaha dealer inspect the brake system.

EWA14212

! WARNING

A soft or spongy feeling in the brake lever can indicate the presence of air in the hydraulic system. If there is air in the hydraulic system, have a Yamaha dealer bleed the system before operating the vehicle. Air in the hydraulic system will diminish the braking performance, which may re-

Checking the front and rear brake pads

EAU22393

The front and rear brake pads must be checked for wear at the intervals specified in the periodic maintenance and lubrication chart.

Front brake pads

EAU36891

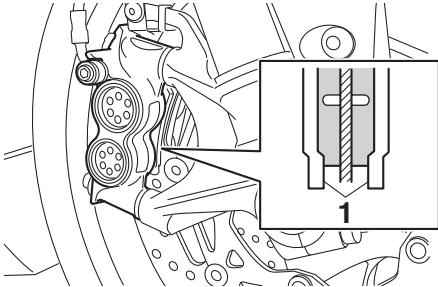

1. Brake pad wear indicator

Each front brake pad is provided with wear indicators, which allows you to check the brake pad wear without having to disassemble the brake. To check the brake pad wear, check the position of the wear indicators while applying the brake. If a brake pad has worn to the point that a wear indicator almost

touches the brake disc, have a Yamaha dealer replace the brake pads as a set.

Rear brake pads

EAU48071

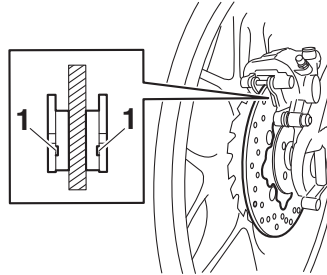

1. Brake pad wear indicator groove

Each rear brake pad is provided with a wear indicator groove, which allows you to check the brake pad wear without having to disassemble the brake. To check the brake pad wear, check the wear indicator groove. If a brake pad has worn to the point that the wear indicator groove almost appears, have a Yamaha dealer replace the brake pads as a set.

Checking the brake fluid level

EAU22582

Before riding, check that the brake fluid is above the minimum level mark. Check the brake fluid level with the top of the reservoir level. Replenish the brake fluid if necessary.

Front brake

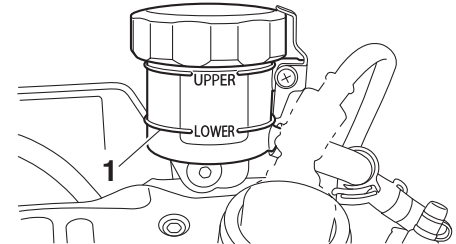

1. Minimum level mark

Periodic maintenance and adjustment

Rear brake

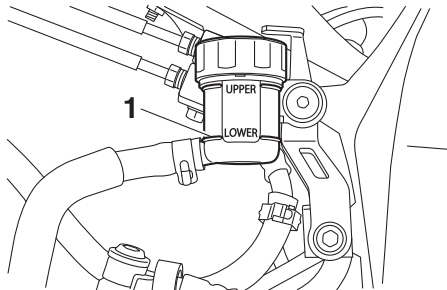

1. Minimum level mark

Specified brake fluid:
DOT 4

EWA15991

⚠ WARNING

Improper maintenance can result in loss of braking ability. Observe these precautions:

- Insufficient brake fluid may allow air to enter the brake system, reducing braking performance.
- Clean the filler cap before removing. Use only DOT 4 brake fluid from a sealed container.
- Use only the specified brake fluid; otherwise, the rubber seals

may deteriorate, causing leakage.

- Refill with the same type of brake fluid. Adding a brake fluid other than DOT 4 may result in a harmful chemical reaction.
- Be careful that water does not enter the brake fluid reservoir when refilling. Water will significantly lower the boiling point of the fluid and may result in vapor lock.

ECA17641

NOTICE

Brake fluid may damage painted surfaces or plastic parts. Always clean up spilled fluid immediately.

As the brake pads wear, it is normal for the brake fluid level to gradually go down. A low brake fluid level may indicate worn brake pads and/or brake system leakage; therefore, be sure to check the brake pads for wear and the brake system for leakage. If the brake fluid level goes down suddenly, have a Yamaha dealer check the cause before further riding.

EAU22733

Changing the brake fluid

Have a Yamaha dealer change the brake fluid at the intervals specified in the periodic maintenance and lubrication chart. In addition, have the oil seals of the master cylinders and calipers as well as the brake hoses replaced at the intervals listed below or whenever they are damaged or leaking.

- Oil seals: Replace every two years.
- Brake hoses: Replace every four years.

Periodic maintenance and adjustment

Drive chain slack

EAU22762

The drive chain slack should be checked before each ride and adjusted if necessary.

To check the drive chain slack

EAU74251

1. Place the motorcycle on the sides-stand.

TIP

When checking and adjusting the drive chain slack, there should be no weight on the motorcycle.

2. Shift the transmission into the neutral position.
3. Measure the drive chain slack as shown.

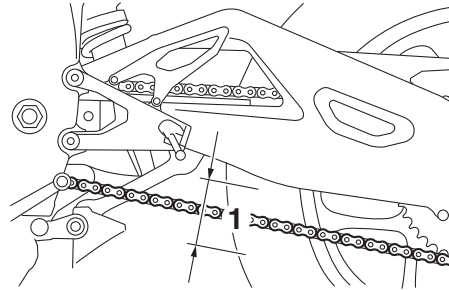

1. Drive chain slack

Drive chain slack:

25.0–35.0 mm (0.98–1.38 in)

4. If the drive chain slack is incorrect, adjust it as follows. **NOTICE: Improper drive chain slack will overload the engine as well as other vital parts of the motorcycle and can lead to chain slippage or breakage. To prevent this from occurring, keep the drive chain slack within the specified limits.**^[ECA10572]

EAU74260

To adjust the drive chain slack

Consult a Yamaha dealer before adjusting the drive chain slack.

1. Loosen the axle nut and the lock-nut on each side of the swingarm.
2. To tighten the drive chain, turn the drive chain slack adjusting bolt on each side of the swingarm in direction (a). To loosen the drive chain, turn the adjusting bolt on each side of the swingarm in direction (b), and then push the rear wheel forward.

TIP

Using the alignment marks on each side of the swingarm, make sure that both drive chain pullers are in the same position for proper wheel alignment.

Periodic maintenance and adjustment

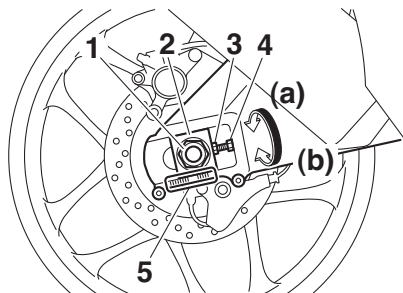

1. Axle nut
2. Drive chain puller
3. Drive chain slack adjusting bolt
4. Locknut
5. Alignment marks

3. Tighten the axle nut, then the locknuts to their specified torques.

Tightening torques:

Axle nut:

190 N·m (19 kgf·m, 137 lb·ft)

Locknut:

16 N·m (1.6 kgf·m, 12 lb·ft)

4. Make sure that the drive chain pullers are in the same position, the drive chain slack is correct, and the drive chain moves smoothly.

EAU23026

Cleaning and lubricating the drive chain

The drive chain must be cleaned and lubricated at the intervals specified in the periodic maintenance and lubrication chart, otherwise it will quickly wear out, especially when riding in dusty or wet areas. Service the drive chain as follows.

ECA10584

NOTICE

The drive chain must be lubricated after washing the motorcycle, riding in the rain or riding in wet areas.

1. Clean the drive chain with kerosene and a small soft brush.
NOTICE: To prevent damaging the O-rings, do not clean the drive chain with steam cleaners, high-pressure washers or inappropriate solvents.^[ECA11122]
2. Wipe the drive chain dry.
3. Thoroughly lubricate the drive chain with a special O-ring chain lubricant. **NOTICE: Do not use engine oil or any other lubricants for the drive chain, as they**

may contain substances that could damage the O-rings.^[ECA11112]

EAU23098

Checking and lubricating the cables

The operation of all control cables and the condition of the cables should be checked before each ride, and the cables and cable ends should be lubricated if necessary. If a cable is damaged or does not move smoothly, have a Yamaha dealer check or replace it. **WARNING! Damage to the outer housing of cables may result in internal rusting and cause interference with cable movement. Replace damaged cables as soon as possible to prevent unsafe conditions.**^[EWA10712]

Recommended lubricant:

Yamaha cable lubricant or other suitable cable lubricant

EAU23115

Checking and lubricating the throttle grip and cable

The operation of the throttle grip should be checked before each ride. In addition, the cable should be lubricated by a Yamaha dealer at the intervals specified in the periodic maintenance chart. The throttle cable is equipped with a rubber cover. Make sure that the cover is securely installed. Even though the cover is installed correctly, it does not completely protect the cable from water entry. Therefore, use care not to pour water directly onto the cover or cable when washing the vehicle. If the cable or cover becomes dirty, wipe clean with a moist cloth.

EAU44276

Checking and lubricating the brake and shift pedals

The operation of the brake and shift pedals should be checked before each ride, and the pedal pivots should be lubricated if necessary.

Brake pedal

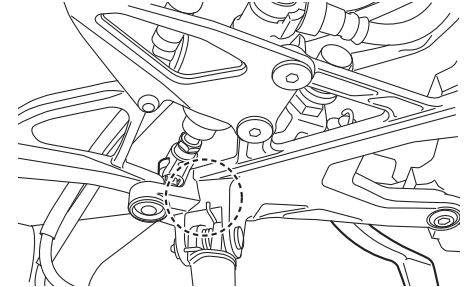

Periodic maintenance and adjustment

Shift pedal

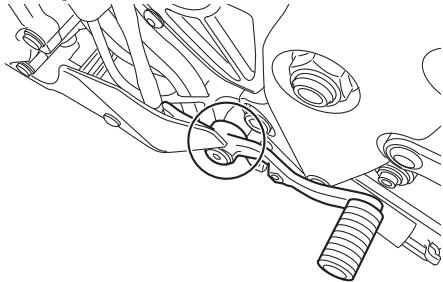

Recommended lubricant:
Lithium-soap-based grease

EAU23144

Checking and lubricating the brake and clutch levers

The operation of the brake and clutch levers should be checked before each ride, and the lever pivots should be lubricated if necessary.

Brake lever

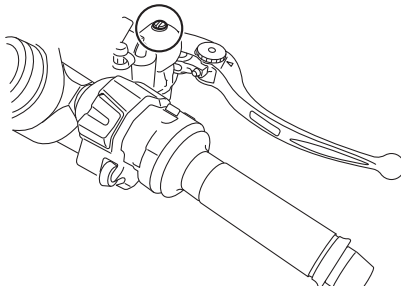

Clutch lever

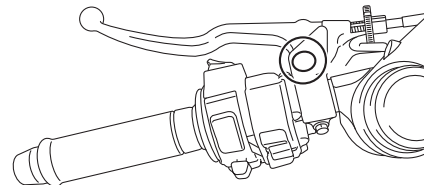

Recommended lubricants:

Brake lever:
Silicone grease
Clutch lever:
Lithium-soap-based grease

EAU23203

Checking and lubricating the sidestand

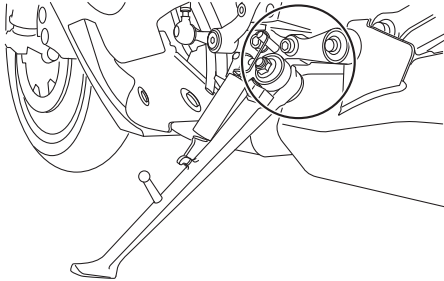

The operation of the sidestand should be checked before each ride, and the sidestand pivot and metal-to-metal contact surfaces should be lubricated if necessary.

EWA10732

WARNING

If the sidestand does not move up and down smoothly, have a Yamaha dealer check or repair it. Otherwise, the sidestand could contact the ground and distract the operator, resulting in a possible loss of control.

Recommended lubricant:
Lithium-soap-based grease

EAUM1653

Lubricating the swingarm pivots

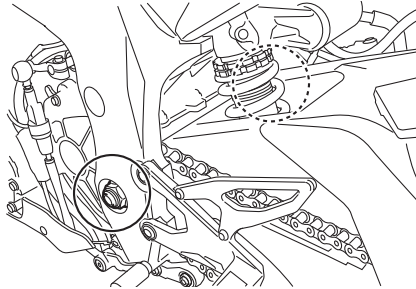

The swingarm pivots must be lubricated by a Yamaha dealer at the intervals specified in the periodic maintenance and lubrication chart.

Recommended lubricant:
Lithium-soap-based grease

EAU23273

Checking the front fork

The condition and operation of the front fork must be checked as follows at the intervals specified in the periodic maintenance and lubrication chart.

To check the condition

Check the inner tubes for scratches, damage and excessive oil leakage.

To check the operation

1. Place the vehicle on a level surface and hold it in an upright position. **WARNING! To avoid injury, securely support the vehicle so there is no danger of it falling over.** [EWA10752]
2. While applying the front brake, push down hard on the handlebars several times to check if the front fork compresses and rebounds smoothly.

Periodic maintenance and adjustment

EAU23285

EAU23292

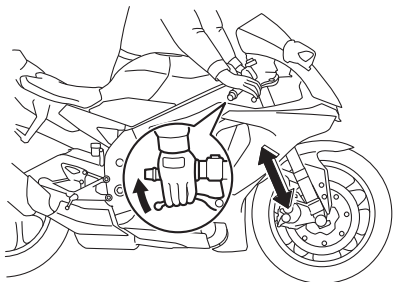

ECA10591

NOTICE

If any damage is found or the front fork does not operate smoothly, have a Yamaha dealer check or repair it.

Checking the steering

Worn or loose steering bearings may cause danger. Therefore, the operation of the steering must be checked as follows at the intervals specified in the periodic maintenance and lubrication chart.

1. Raise the front wheel off the ground. (See page 7-37.)

WARNING! To avoid injury, securely support the vehicle so there is no danger of it falling over. [EWA10752]

2. Hold the lower ends of the front fork legs and try to move them forward and backward. If any free play can be felt, have a Yamaha dealer check or repair the steering.

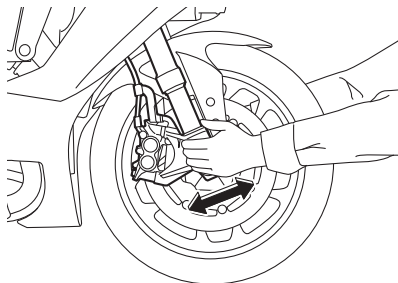

Checking the wheel bearings

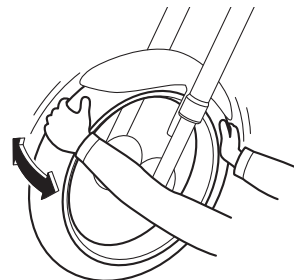

The front and rear wheel bearings must be checked at the intervals specified in the periodic maintenance and lubrication chart. If there is play in the wheel hub or if the wheel does not turn smoothly, have a Yamaha dealer check the wheel bearings.

Periodic maintenance and adjustment

Battery

EAU68230

ECA22960

NOTICE

Use only the specified genuine YAMAHA battery. Using a different battery may cause the IMU to fail and the engine to stall.

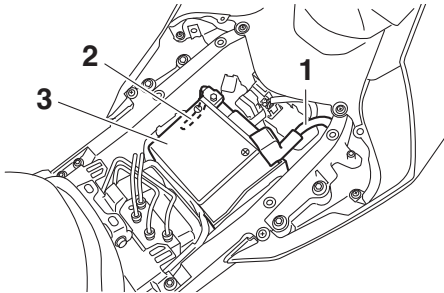

1. Positive battery lead (red)
2. Negative battery lead (black)
3. Battery

The battery is located under the rider seat. (See page 4-37.)

ECA22970

NOTICE

The IMU is located under the battery. It is not user serviceable and very sensitive, so we advise against re-

moving the battery box or handling the IMU directly.

- Do not remove, modify, or place any foreign materials in or around the battery box.
- Do not subject the IMU to strong shocks and be careful when handling the battery.
- Do not obstruct the IMU breather hole and do not clean it with compressed air.

This model is equipped with a VRLA (Valve Regulated Lead Acid) battery. There is no need to check the electrolyte or to add distilled water. However, the battery lead connections need to be checked and, if necessary, tightened.

EWA10761

⚠ WARNING

- **Electrolyte is poisonous and dangerous since it contains sulfuric acid, which causes severe burns. Avoid any contact with skin, eyes or clothing and always shield your eyes when working near batteries. In case of contact, administer the fol-**

lowing FIRST AID.

- **EXTERNAL:** Flush with plenty of water.
- **INTERNAL:** Drink large quantities of water or milk and immediately call a physician.
- **EYES:** Flush with water for 15 minutes and seek prompt medical attention.
- Batteries produce explosive hydrogen gas. Therefore, keep sparks, flames, cigarettes, etc., away from the battery and provide sufficient ventilation when charging it in an enclosed space.
- **KEEP THIS AND ALL BATTERIES OUT OF THE REACH OF CHILDREN.**

To charge the battery

Have a Yamaha dealer charge the battery as soon as possible if it seems to have discharged. Keep in mind that the battery tends to discharge more quickly if the vehicle is equipped with optional electrical accessories.

Periodic maintenance and adjustment

ECA16522

NOTICE

To charge a VRLA (Valve Regulated Lead Acid) battery, a special (constant-voltage) battery charger is required. Using a conventional battery charger will damage the battery.

To store the battery

1. If the vehicle will not be used for more than one month, remove the battery, fully charge it, and then place it in a cool, dry place.

NOTICE: When removing the battery, be sure the key is turned to “OFF”, then disconnect the negative lead before disconnecting the positive lead.

2. If the battery will be stored for more than two months, check it at least once a month and fully charge it if necessary.
3. Fully charge the battery before installation. **NOTICE:** When installing the battery, be sure the key is turned to “OFF”, then connect the positive lead before

connecting the negative lead.

4. After installation, make sure that the battery leads are properly connected to the battery terminals.

ECA16531

NOTICE

Always keep the battery charged. Storing a discharged battery can cause permanent battery damage.

EAU66592

Replacing the fuses

The main fuse and ABS motor fuse are located under the rider seat.

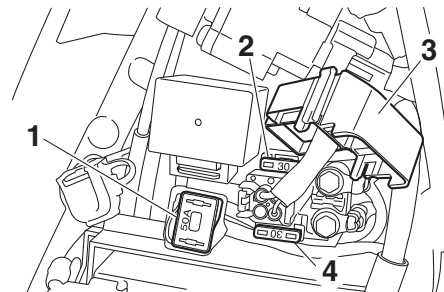

1. Main fuse
2. ABS motor fuse
3. Starter relay cover
4. ABS motor spare fuse

To access the ABS motor fuse

1. Remove the passenger seat and rider seat. (See page 4-37.)
2. Remove the panel by removing the screws.

Periodic maintenance and adjustment

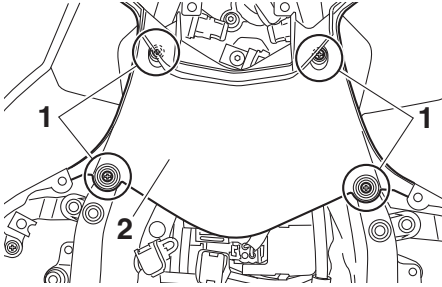

1. Screw
2. Panel

3. Remove the starter relay cover by pulling it upward.

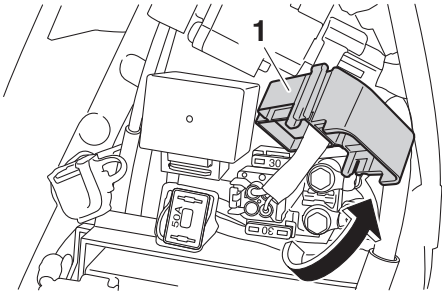

1. Starter relay cover

The fuse boxes, which contain the fuses for the individual circuits, are located under panel A. (See page 7-9.)

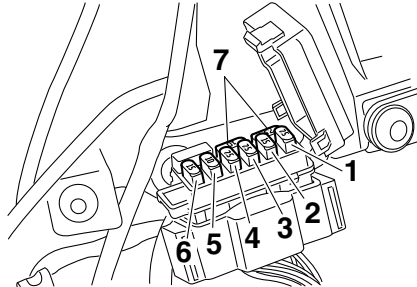

1. Hazard fuse
2. Fuel injection system fuse
3. Electronic throttle valve fuse
4. Backup fuse
5. Sub radiator fan motor fuse
6. Radiator fan motor fuse
7. Spare fuse

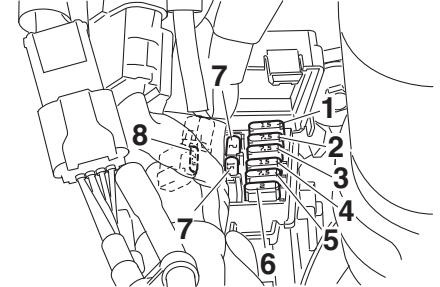

1. Ignition fuse
2. Signaling system fuse
3. ABS ECU fuse
4. ABS solenoid fuse
5. Headlight fuse
6. Terminal fuse 1
7. Spare fuse
8. SCU fuse (YZF-R1M)

If a fuse is blown, replace it as follows.

1. Turn the key to "OFF" and turn off the electrical circuit in question.
2. Remove the blown fuse, and then install a new fuse of the specified amperage. **WARNING! Do not use a fuse of a higher amperage rating than recommended to avoid causing extensive damage to the electrical system and possibly a fire.**[EWA15132]

Periodic maintenance and adjustment

Specified fuses:

Main fuse:	50.0 A
Terminal fuse 1:	2.0 A
Headlight fuse:	7.5 A
Signaling system fuse:	7.5 A
Ignition fuse:	15.0 A
Radiator fan motor fuse:	15.0 A
Sub radiator fan motor fuse:	10.0 A
ABS motor fuse:	30.0 A
Hazard fuse:	7.5 A
ABS ECU fuse:	7.5 A
ABS solenoid fuse:	15.0 A
SCU fuse:	7.5 A (YZF-R1M)
Fuel injection system fuse:	15.0 A
Backup fuse:	7.5 A
Electronic throttle valve fuse:	7.5 A

3. Turn the key to “ON” and turn on the electrical circuit in question to

check if the device operates.
4. If the fuse immediately blows again, have a Yamaha dealer check the electrical system.

Vehicle lights

EAU67121

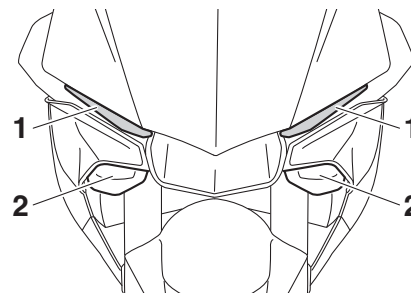

1. Auxiliary light
2. Headlight

This model is equipped with full-LED lighting.

The headlights, auxiliary lights, turn signals, tail/brake light, and license plate light are all LED. There are no user replaceable bulbs.



If a light does not come on, check the fuses and then have a Yamaha dealer check the vehicle.

ECA16581

NOTICE

Do not affix any type of tinted film or stickers to the headlight lens.

TIP

- The right headlight comes on when Pass/LAP switch “/LAP” is pushed or the dimmer switch is set to “” (high beam).
- The auxiliary lights were designed to fade out as your R1 goes to sleep.

Supporting the motorcycle

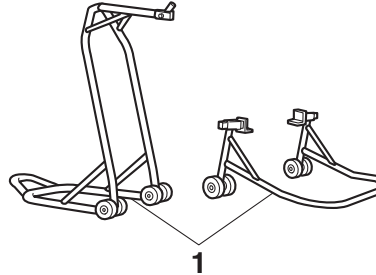

1. Maintenance stand (example)

Since this model is not equipped with a centerstand, use maintenance stands when removing the front or rear wheel or when performing other maintenance that requires the motorcycle to stand up right.

Check that the motorcycle is in a stable and level position before starting any maintenance.

Troubleshooting

Although Yamaha motorcycles receive a thorough inspection before shipment from the factory, trouble may occur during operation. Any problem in the fuel, compression, or ignition systems, for example, can cause poor starting and loss of power.

The following troubleshooting charts represent quick and easy procedures for checking these vital systems yourself. However, should your motorcycle require any repair, take it to a Yamaha dealer, whose skilled technicians have the necessary tools, experience, and know-how to service the motorcycle properly.

Use only genuine Yamaha replacement parts. Imitation parts may look like Yamaha parts, but they are often inferior, have a shorter service life and can lead to expensive repair bills.

WARNING

When checking the fuel system, do not smoke, and make sure there are no open flames or sparks in the area, including pilot lights from water

Periodic maintenance and adjustment

heaters or furnaces. Gasoline or gasoline vapors can ignite or explode, causing severe injury or property damage.

Troubleshooting charts

Starting problems or poor engine performance

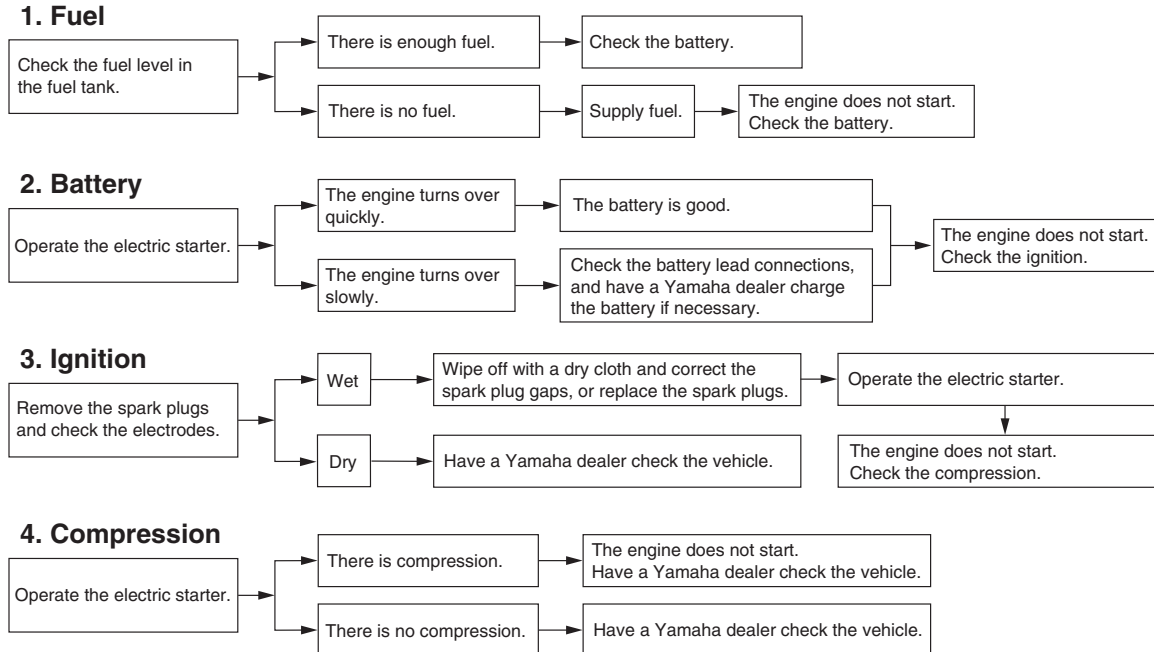

Periodic maintenance and adjustment

Engine overheating

EWAT1041

WARNING

- Do not remove the radiator cap when the engine and radiator are hot. Scalding hot fluid and steam may be blown out under pressure, which could cause serious injury. Be sure to wait until the engine has cooled.
 - Place a thick rag, like a towel, over the radiator cap, and then slowly rotate the cap counterclockwise to the detent to allow any residual pressure to escape. When the hissing sound has stopped, press down on the cap while turning it counterclockwise, and then remove the cap.
-

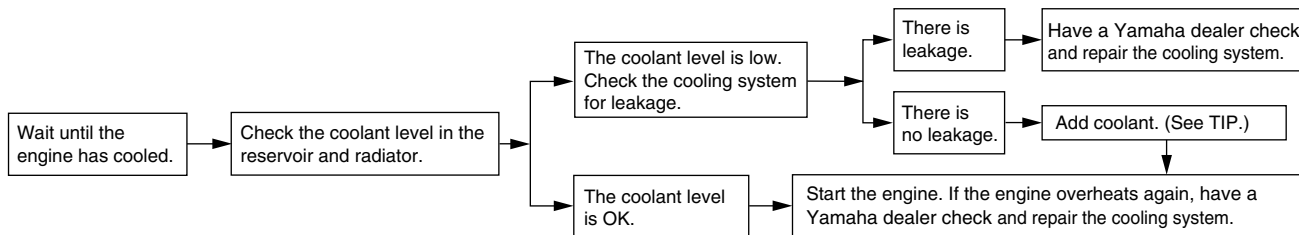

TIP

If coolant is not available, tap water can be temporarily used instead, provided that it is changed to the recommended coolant as soon as possible.

Matte color caution

EAU37834

EAU67140

NOTICE

Some models are equipped with matte colored finished parts. Be sure to consult a Yamaha dealer for advice on what products to use before cleaning the vehicle. Using a brush, harsh chemical products or cleaning compounds when cleaning these parts will scratch or damage their surface. Wax also should not be applied to any matte colored finished parts.

ECA15193

Care

While the open design of a motorcycle reveals the attractiveness of the technology, it also makes it more vulnerable. Rust and corrosion can develop even if high-quality components are used. A rusty exhaust pipe may go unnoticed on a car, however, it detracts from the overall appearance of a motorcycle. Frequent and proper care does not only comply with the terms of the warranty, but it will also keep your motorcycle looking good, extend its life and optimize its performance.

Before cleaning

1. Cover the muffler outlet with a plastic bag after the engine has cooled down.
2. Make sure that all caps and covers as well as all electrical couplers and connectors, including the spark plug caps, are tightly installed.
3. Remove extremely stubborn dirt, like oil burnt onto the crankcase, with a degreasing agent and a brush, but never apply such prod-

ucts onto seals, gaskets, sprockets, the drive chain and wheel axles. Always rinse the dirt and degreaser off with water.

Cleaning

ECA22530

NOTICE

- Avoid using strong acidic wheel cleaners, especially on spoked or magnesium wheels. If such products are used on hard-to-remove dirt, do not leave the cleaner on the affected area any longer than instructed. Also, thoroughly rinse the area off with water, immediately dry it, and then apply a corrosion protection spray.
- Improper cleaning can damage such parts as cowlings and panels, the windshield, the instrument panel and display, wheels, headlight lenses, plastic or carbon fiber parts, etc., and the mufflers. Use only a soft, clean cloth or sponge to clean such parts. However, if such parts cannot be thoroughly cleaned,

Motorcycle care and storage

water and diluted mild detergent may be used. Be sure to rinse off any detergent residue using plenty of water, as it is harmful to plastic parts.

- Do not use any harsh chemical products on plastic parts or the muffler. Be sure to avoid using cloths or sponges which have been in contact with strong or abrasive cleaning products, solvent or thinner, fuel (gasoline), rust removers or inhibitors, brake fluid, antifreeze or electrolyte.
 - Do not use high-pressure washers or steam-jet cleaners since they cause water seepage and deterioration in the following areas: seals (of wheel and swing-arm bearings, fork and brakes), storage compartments, electric components (couplers, connectors, instruments, switches and lights), breather hoses and vents.
-

After normal use

Remove dirt with warm water, a mild detergent, and a soft, clean sponge, and then rinse thoroughly with clean water. Use a toothbrush or bottlebrush for hard-to-reach areas. Stubborn dirt and insects will come off more easily if the area is covered with a wet cloth for a few minutes before cleaning.

After riding in the rain, near the sea or on salt-sprayed roads

Since sea salt or salt sprayed on roads during winter are extremely corrosive in combination with water, carry out the following steps after each ride in the rain, near the sea or on salt-sprayed roads.

TIP

Salt sprayed on roads in the winter may remain well into spring.

1. Clean the motorcycle with cold water and a mild detergent, after the engine has cooled down.

NOTICE: Do not use warm water since it increases the corrosive action of the salt.^[ECA10792]

2. After drying the motorcycle, apply

a corrosion protection spray on all metal, including chrome- and nickel-plated, surfaces (except the titanium muffler) to prevent corrosion.

Cleaning the windshield

Avoid using any alkaline or strong acid cleaner, gasoline, brake fluid, or any other solvent. Clean the windshield with a cloth or sponge dampened with a neutral detergent, and after cleaning, thoroughly wash it off with water. For additional cleaning, use Yamaha Windshield Cleaner or other quality cleaner. Some cleaning compounds for plastics may leave scratches on surfaces of the windshield. Before using them, make a test by polishing an area which does not affect your visibility.

Cleaning the titanium muffler

This model is equipped with a titanium muffler, which requires the following special care.

- Use only a soft, clean cloth or sponge with mild detergent and water to clean the titanium muffler. However, if the muffler cannot be thoroughly cleaned with mild de-

tergent, alkaline products and a soft brush may be used.

- Never use compounds or other special treatments to clean the titanium muffler, as they will remove the finish on the outer surface of the muffler.
- Even the smallest amounts of oil, such as from oily towels or fingerprints, will leave stains on the titanium muffler, which can be removed with a mild detergent.
- Note that the thermally induced discoloring of the portion of the exhaust pipe leading into the titanium muffler is normal and cannot be removed.

After cleaning

1. Dry the motorcycle with a chamois or an absorbing cloth.
2. Immediately dry the drive chain and lubricate it to prevent it from rusting.
3. Use a chrome polish to shine chrome, aluminum and stainless-steel parts.
4. To prevent corrosion, it is recommended to apply a corrosion pro-

tection spray on all metal, including chrome- and nickel-plated, surfaces.

5. Use spray oil as a universal cleaner to remove any remaining dirt.
6. Touch up minor paint damage caused by stones, etc.
7. Wax all painted surfaces.
8. Let the motorcycle dry completely before storing or covering it.

EWA11132

WARNING

Contaminants on the brakes or tires can cause loss of control.

- **Make sure that there is no oil or wax on the brakes or tires.**
- **If necessary, clean the brake discs and brake linings with a regular brake disc cleaner or acetone, and wash the tires with warm water and a mild detergent. Before riding at higher speeds, test the motorcycle's braking performance and cornering behavior.**

ECA10801

NOTICE

- **Apply spray oil and wax spar-**

ingly and make sure to wipe off any excess.

- **Never apply oil or wax to any rubber and plastic parts, but treat them with a suitable care product.**
- **Avoid using abrasive polishing compounds as they will wear away the paint.**

TIP

- Consult a Yamaha dealer for advice on what products to use.
- Washing, rainy weather or humid climates can cause the headlight lens to fog. Turning the headlight on for a short period of time will help remove the moisture from the lens.

Motorcycle care and storage

Storage

EAU26183

Short-term

Always store your motorcycle in a cool, dry place and, if necessary, protect it against dust with a porous cover. Be sure the engine and the exhaust system are cool before covering the motorcycle.

ECA10811

NOTICE

- **Storing the motorcycle in a poorly ventilated room or covering it with a tarp, while it is still wet, will allow water and humidity to seep in and cause rust.**
- **To prevent corrosion, avoid damp cellars, stables (because of the presence of ammonia) and areas where strong chemicals are stored.**

Long-term

Before storing your motorcycle for several months:

1. Follow all the instructions in the “Care” section of this chapter.

2. Fill up the fuel tank and add fuel stabilizer (if available) to prevent the fuel tank from rusting and the fuel from deteriorating.
3. Perform the following steps to protect the cylinders, piston rings, etc. from corrosion.
 - a. Remove the spark plug caps and spark plugs.
 - b. Pour a teaspoonful of engine oil into each spark plug bore.
 - c. Install the spark plug caps onto the spark plugs, and then place the spark plugs on the cylinder head so that the electrodes are grounded. (This will limit sparking during the next step.)
 - d. Turn the engine over several times with the starter. (This will coat the cylinder walls with oil.)
WARNING! To prevent damage or injury from sparking, make sure to ground the spark plug electrodes while turning the engine over.^[EWA10952]
 - e. Remove the spark plug caps from the spark plugs, and then install the spark plugs and the spark plug caps.
4. Lubricate all control cables and the pivoting points of all levers and pedals as well as of the sidestand/centerstand.
5. Check and, if necessary, correct the tire air pressure, and then lift the motorcycle so that both of its wheels are off the ground. Alternatively, turn the wheels a little every month in order to prevent the tires from becoming degraded in one spot.
6. Cover the muffler outlet with a plastic bag to prevent moisture from entering it.
7. Remove the battery and fully charge it. Store it in a cool, dry place and charge it once a month. Do not store the battery in an excessively cold or warm place [less than 0 °C (30 °F) or more than 30 °C (90 °F)]. For more information on storing the battery, see page 7-33.

TIP

Make any necessary repairs before storing the motorcycle.

Dimensions:

- Overall length:
2055 mm (80.9 in)
- Overall width:
690 mm (27.2 in)
- Overall height:
1150 mm (45.3 in)
- Seat height:
855 mm (33.7 in) (YZF-R1)
860 mm (33.9 in) (YZF-R1M)
- Wheelbase:
1405 mm (55.3 in)
- Ground clearance:
130 mm (5.12 in)
- Minimum turning radius:
3.3 m (10.83 ft)

Weight:

- Curb weight:
200 kg (441 lb) (YZF-R1)
201 kg (443 lb) (YZF-R1M)

Engine:

- Combustion cycle:
4-stroke
- Cooling system:
Liquid cooled
- Valve train:
DOHC
- Cylinder arrangement:
Inline
- Number of cylinders:
4-cylinder
- Displacement:
998 cm³

Bore × stroke:

79.0 × 50.9 mm (3.11 × 2.00 in)

Compression ratio:

13.0 : 1

Starting system:

Electric starter

Lubrication system:

Wet sump

Engine oil:

Recommended brand:

YAMALUBE

Type:

Full synthetic

SAE viscosity grades:

10W-40, 15W-50

Recommended engine oil grade:

API service SG type or higher, JASO standard MA

Engine oil quantity:

Oil change:

3.90 L (4.12 US qt, 3.43 Imp.qt)

With oil filter removal:

4.10 L (4.33 US qt, 3.61 Imp.qt)

Coolant quantity:

Coolant reservoir (up to the maximum level mark):

0.25 L (0.26 US qt, 0.22 Imp.qt)

Radiator (including all routes):

2.25 L (2.38 US qt, 1.98 Imp.qt)

Air filter:

Air filter element:

Oil-coated paper element

Fuel:

Recommended fuel:

Premium unleaded gasoline (Gasohol [E10] acceptable)

Fuel tank capacity:

17 L (4.5 US gal, 3.7 Imp.gal)

Fuel reserve amount:

3.0 L (0.79 US gal, 0.66 Imp.gal)

Fuel injection:

Throttle body:

ID mark:

2CR4

Spark plug(s):

Manufacturer/model:

NGK/LMAR9E-J

Spark plug gap:

0.6–0.7 mm (0.024–0.028 in)

Clutch:

Clutch type:

Wet, multiple-disc

Drivetrain:

Primary reduction ratio:

1.634 (67/41)

Final drive:

Chain

Secondary reduction ratio:

2.563 (41/16)

Transmission type:

Constant mesh 6-speed

Gear ratio:

1st:

2.600 (39/15)

2nd:

2.176 (37/17)

Specifications

- 3rd: 1.842 (35/19)
- 4th: 1.579 (30/19)
- 5th: 1.381 (29/21)
- 6th: 1.250 (30/24)

Chassis:

- Frame type: Diamond
- Caster angle: 24.0 °
- Trail: 102 mm (4.0 in)

Front tire:

- Type: Tubeless
- Size: 120/70 ZR17MC (58W)
- Manufacturer/model: BRIDGESTONE/BATTLAX RACING STREET RS10F

Rear tire:

- Type: Tubeless
- Size: 190/55 ZR17M/C (75W) (YZF-R1)
200/55 ZR17M/C (78W) (YZF-R1M)
- Manufacturer/model: BRIDGESTONE/BATTLAX RACING STREET RS10R

Loading:

- Maximum load: 187 kg (412 lb)
- * (Total weight of rider, passenger, cargo and accessories)

Tire air pressure (measured on cold tires):

- Front: 250 kPa (2.50 kgf/cm², 36 psi)
- Rear: 290 kPa (2.90 kgf/cm², 42 psi)

Front wheel:

- Wheel type: Cast wheel
- Rim size: 17M/C x MT3.50

Rear wheel:

- Wheel type: Cast wheel
- Rim size: 17M/C x MT6.00

Unified brake system:

- Operation: Activated by front brake

Front brake:

- Type: Hydraulic dual disc brake
- Specified brake fluid: DOT 4

Rear brake:

- Type: Hydraulic single disc brake
- Specified brake fluid: DOT 4

Front suspension:

- Type: Telescopic fork
- Spring: Coil spring
- Shock absorber: Hydraulic damper
- Wheel travel: 120 mm (4.7 in)

Rear suspension:

- Type: Swingarm (link suspension)
- Spring: Coil spring
- Shock absorber: Gas-hydraulic damper
- Wheel travel: 120 mm (4.7 in)

Electrical system:

- System voltage: 12 V
- Ignition system: TCI
- Charging system: AC magneto

Battery:

- Model: YTZ7S
- Voltage, capacity: 12 V, 6.0 Ah (10 HR)

Bulb wattage:

- Headlight: LED

Brake/tail light: LED	Immobilizer system indicator light: LED	Electronic throttle valve fuse: 7.5 A
Front turn signal light: LED	Shift timing indicator light: LED	
Rear turn signal light: LED	Fuse(s):	
Auxiliary light: LED	Main fuse: 50.0 A	
License plate light: LED	Terminal fuse 1: 2.0 A	
Meter lighting: LED	Headlight fuse: 7.5 A	
Neutral indicator light: LED	Signaling system fuse: 7.5 A	
High beam indicator light: LED	Ignition fuse: 15.0 A	
Turn signal indicator light: LED	Radiator fan motor fuse: 15.0 A	
Stability control indicator light: LED	Sub radiator fan motor fuse: 10.0 A	
Oil pressure and coolant temperature warning light: LED	Hazard fuse: 7.5 A	
Fuel level warning light: LED	ABS ECU fuse: 7.5 A	
Coolant temperature warning light: LED	Fuel injection system fuse: 15.0 A	
Engine trouble warning light: LED	SCU fuse: 7.5 A (YZF-R1M)	
Steering damper and suspension warning light: LED	ABS motor fuse: 30.0 A	
ABS warning light: LED	ABS solenoid fuse: 15.0 A	
	Backup fuse: 7.5 A	

Consumer information

EAU53562

Identification numbers

Record the vehicle identification number, engine serial number, and the model label information in the spaces provided below. These identification numbers are needed when registering the vehicle with the authorities in your area and when ordering spare parts from a Yamaha dealer.

VEHICLE IDENTIFICATION NUMBER:

ENGINE SERIAL NUMBER:

MODEL LABEL INFORMATION:

Vehicle identification number

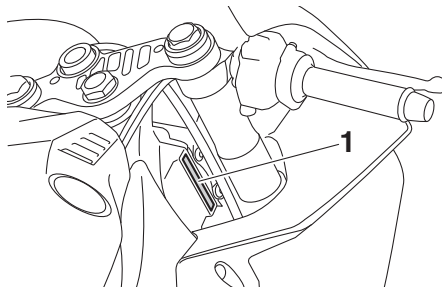

1. Vehicle identification number

The vehicle identification number is stamped into the steering head pipe. Record this number in the space provided.

TIP _____

The vehicle identification number is used to identify your motorcycle and may be used to register your motorcycle with the licensing authority in your area.

EAU26401

Engine serial number

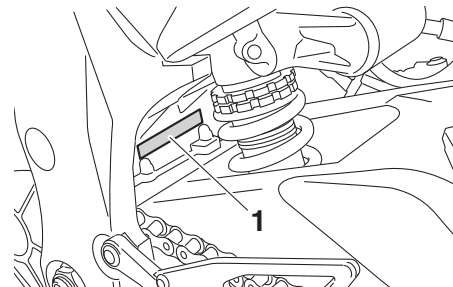

1. Engine serial number

The engine serial number is stamped into the crankcase.

EAU26442

EAU26521

Model label

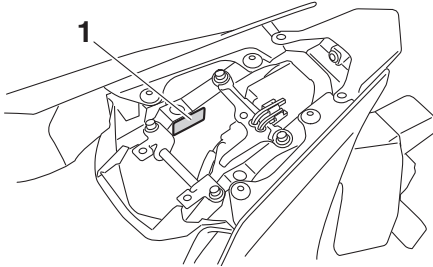

1. Model label

The model label is affixed to the frame under the passenger seat. (See page 4-37.) Record the information on this label in the space provided. This information will be needed when ordering spare parts from a Yamaha dealer.

EAU69910

Diagnostic connector

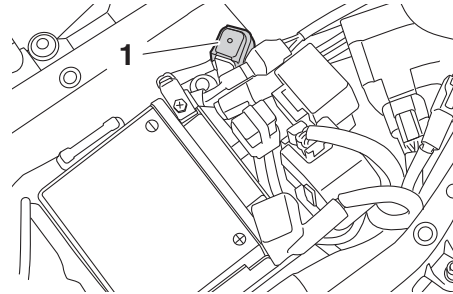

1. Diagnostic connector

The diagnostic connector is located as shown.

EAU74701

Vehicle data recording

This model's ECU stores certain vehicle data to assist in the diagnosis of malfunctions and for research and development purposes. This data will be uploaded only when a special Yamaha diagnostic tool is attached to the vehicle, such as when maintenance checks or service procedures are performed.

Although the sensors and recorded data will vary by model, the main data points are:

- Vehicle status and engine performance data
- Fuel-injection and emission-related data

Yamaha will not disclose this data to a third party except:

- With the consent of the vehicle owner
- Where obligated by law
- For use by Yamaha in litigation
- For general Yamaha-conducted research purposes when the data is not related to an individual vehicle nor owner

Index

- A**
ABS warning light..... 4-6
Air filter element..... 7-18
Auxiliary DC connector 4-46
- B**
Battery..... 7-33
Brake and clutch levers, checking and lubricating 7-30
Brake and shift pedals, checking and lubricating 7-29
Brake fluid, changing 7-26
Brake fluid level, checking 7-25
Brake lever..... 4-31
Brake lever free play, checking..... 7-24
Brake light switches 7-24
Brake pedal..... 4-31
Brake system 4-32
- C**
Cables, checking and lubricating 7-29
Canister..... 7-13
Care 8-1
Catalytic converter 4-36
CCU 4-38
Clutch lever 4-30
Clutch lever free play, adjusting..... 7-23
Coolant..... 7-16
Cowlings and panels, removing and installing..... 7-9
- D**
Data recording, vehicle 10-2
Diagnostic connector 10-2
Dimmer switch 4-4
Display, main screen..... 4-9
Display, menu screen 4-15
- Document storage 4-39
Drive chain, cleaning and lubricating.... 7-28
Drive chain slack 7-27
- E**
Engine break-in 6-3
Engine idling speed, checking 7-19
Engine oil and oil filter cartridge 7-13
Engine serial number..... 10-1
Engine trouble warning light 4-6
EXUP system 4-46
- F**
Front and rear brake pads, checking.... 7-25
Front fork, adjusting..... 4-40
Front fork, checking..... 7-31
Fuel..... 4-34
Fuel consumption, tips for reducing..... 6-3
Fuel level warning light 4-6
Fuel tank breather hose and overflow hose 4-36
Fuel tank cap..... 4-33
Fuses, replacing 7-34
- G**
Glossary 3-3
- H**
Handlebar switches 4-3
Hazard switch 4-4
High beam indicator light..... 4-6
Horn switch..... 4-4
- I**
Identification numbers 10-1
Ignition circuit cut-off system 4-47
Immobilizer system..... 4-1
Immobilizer system indicator light..... 4-7
Indicator lights and warning lights 4-6
- M**
Main switch/steering lock 4-2
Maintenance and lubrication, periodic..... 7-5
Maintenance, emission control system ... 7-3
Matte color, caution..... 8-1
Model label..... 10-2
- N**
Neutral indicator light 4-6
- O**
Oil pressure and coolant temperature warning light..... 4-8
- P**
Parking..... 6-4
Part locations 2-1
Pass/LAP switch 4-4
- R**
Rear view mirrors 4-40
- S**
Safety information 1-1
Seats 4-37
Shifting 6-2
Shift pedal 4-30
Shift timing indicator light 4-7
Shock absorber assembly, adjusting ... 4-42
Sidestand 4-47
Sidestand, checking and lubricating..... 7-31
Spark plugs, checking 7-12
Special features 3-1
Specifications 9-1
Stability control indicator light..... 4-7
Starting the engine 6-1
Steering, checking..... 7-32
Steering damper and suspension warning light..... 4-8

Stop/Run/Start switch	4-4
Storage	8-4
Supporting the motorcycle	7-37
Swingarm pivots, lubricating	7-31

T

Throttle grip and cable, checking and lubricating	7-29
Throttle grip free play, checking	7-19
Tires	7-20
Tool kit	7-2
Troubleshooting	7-37
Troubleshooting charts	7-39
Turn signal indicator light	4-6
Turn signal switch	4-4

V

Valve clearance	7-19
Vehicle identification number	10-1
Vehicle lights	7-36

W

Wheel bearings, checking	7-32
Wheels	7-22

Y

YRC functions visual guide	3-4
YRC settings	4-16
YRC (Yamaha Ride Control)	3-1

